

Structural elements



Reliable retention – for a lifetime!

bredent

Structural elements

Retention elements for removable and partially removable restorations

More than 30 years bredent has been developing, manufacturing and selling innovative retention elements, such as attachments, lock systems and abutments for implant systems. All retention elements are available in types and connection geometries matched to the patients' requests to ensure maximum wearing comfort and reliability. The possibility of customization of the retention elements enables precise and cost-effective fabrication of the restoration and a perfect design ensuring periodontal hygiene.

The proven three-color system is available with different pull-off forces of the matrices as ball, rod or bar attachments in innovative materials. They ensure safe retention of the prosthetic restoration, durability and enable to adapt the pull-off force to the patient's situation without the need to change the design. Each attachment solution of bredent is a system of auxiliary modelling elements or exchangeable finished products for the patrix and matrix as well as the accessories required for the dental fabrication. Accordingly, simple and reliable processing by the dental technician is guaranteed the dentist is enabled to offer treatment free from complications.

Simple solutions to meet highest demands

Removable restorations are becoming more and more important in rapidly changing dental techniques, in particular in combination with fixed implant restorations. Patients want to

have favorably-priced high-quality restorations. That is why we offer simple solutions for removable restoration to meet the demands.



Partially removable restorations that are easy to clean

Partially removable restorations with splint or screw connections are perfectly suitable to enable professional cleaning of complex implant restorations. Patented and firmly retained

screws for added reliability are available or solutions without threads are offered to enable simpler processing.



Ready-made transversal screw retention

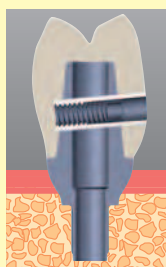

Friction Splint

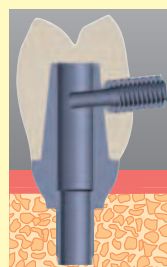

Security-Lock-System

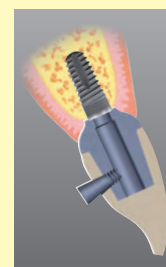

Individual screw retention

Attachments – snap or friction?

Attachments are the retention systems most frequently used for removable restorations since they can be easily used thanks to simple handling. The attachments combine utmost reliability with small size and also offer superior wearing comfort.

Simple and systematic adjustment of the friction using the green-red-yellow matrices for individual pull-off forces enable patient-specific handling and provide patients with a feeling of utmost reliability.

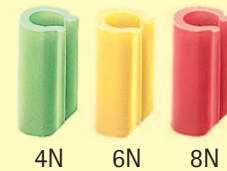

breident attachments made of burn-out resin elements for casting in various alloys allow the fabrication of favorably-priced restorations and also offer high flexibility. The

type of attachment is selected depending on the situation and mobility of the patient.



Ball attachments

Ball attachments are the classic product among attachments and are suitable for universal use. The snap effect of the ma-

trices offers the patient comfort and safety.

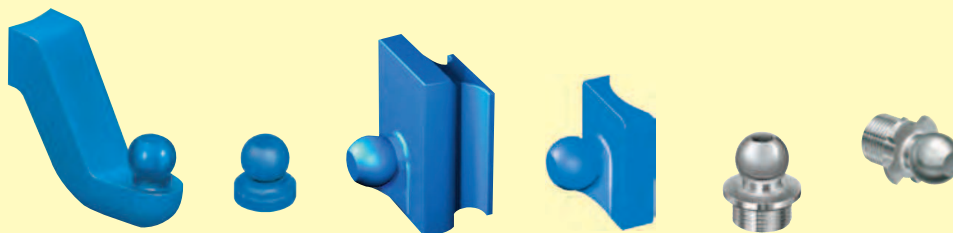

Rod attachments

Thanks to a friction surface, the rod attachments provide high reliability during gently insertion of the denture. The various

types are suitable for the use both in the anterior and posterior region.



Bar attachments

Thanks to three different types – friction, joint, friction-snap – the profile bar provides all options for any situation and is

perfectly suited for high-quality implant restorations.



Structural elements



Locks – the convenient solution for high-quality restorations!

Locks are the alternative to attachments since they enable anchoring of removable restorations that is free from friction and yet still firm. Hence the lock solutions are indicated for implant-supported dentures. Monoreductors that provide reliable retention can also be fabricated. The different types

are simply integrated into the restoration depending on the space available.



Retention elements – clever ideas for safe retention!

Individual retention elements are integrated into the secondary crown and enable to adjust the friction to the patient's requirements. They can also be integrated into telescopic

crowns as an additional retention element. Various designs and materials of additional retention elements ensure safe hold of removable restorations.



Screw retentions – fixed or removable?

Different solutions are available for partially removable restorations on implants. Patented solutions are available for fixed

and partially removable restorations – ranging from individual screw connections to splint connections without thread.

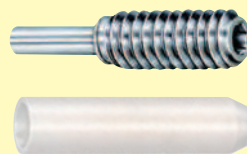

Attachments and digital restorations

The patrices are included in the libraries of various systems and are integrated directly into the digital design. The data

are available at www.caelo-dental.net to be used for further processing.

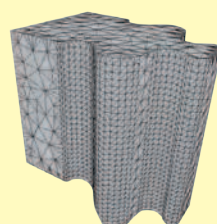

Product description

The attachments are divided into different categories. Below you can find all the information necessary for simple and fast selection and for reliable processing:

Attachments



Ball attachments

	Page	Implant	Function	Intra-coronal	Extra-coronal	Bar	Material	Integrated shear distributor	Exchangeable	Digital workflow
vks-oc	8	X	snap	X	X	X	HL / Resin			CoCr/Titanium/Zirconium
vks-sg	13	X	snap	X		X	Resin	X		CoCr/Titanium/Zirconium
vks-sg Bar	17	X	snap			X	Titanium / Resin			
vks-oc / sg exchangeable stud	11	X	snap	X		X	HL		X	CoCr/Titanium/Zirconium



Rod attachments

	Page	Implant	Function	Material	Integrated shear distributor	Thermoplastic use	Digital workflow
vs 3	21	X	Friction	Resin		X	CoCr/Titanium
vs 3 sv	23	X	Friction	Resin	X	X	CoCr/Titanium/Zirconium
vs 3 mini	25	X	Friction	Resin		X	
vs 3 mini sv	27	X	Friction	Resin	X	X	CoCr/Titanium/Zirconium
vs 3 conical bridge	28	X	Partially removable	Resin			
Inverto Plus	29	X	Friction	Titanium / HL			



Bar attachments

	Page	Implant	Function	Material	Thermoplastic use	Digital workflow
vsp-f	32	X	Friction	Resin / Titanium	X	CoCr/Titanium
vsp-fs	33	X	Friction / Snap	Resin / Titaniu	X	CoCr/Titanium
vsp-gs	33	X	Joint / Snap	Resin / Titaniu	X	CoCr/Titanium
vss	34		Friction	Resin	X	



Locks

	Page	Implant	Function	Design	Material	Integrated shear distributor
Swivel-type lock src	57	X	Frictionless	Swivel-type lock	Titanium	X
Swivel-type lock sr	55	X	Frictionless	Swivel-type lock	individual	X
Locking Pin Snap-System	42	X	Frictionless	Locking Pin	Titanium / HL / Pt-Ir	
Locking Pin Easy-Snap	38	X	Frictionless	Locking Pin	Titanium / HL / Pt-Ir	
Locking Pin activatable	49	X	Frictionless	Locking Pin	Titanium / High-grade steel	
Locking Pin bs1	51	X	Frictionless	Locking Pin	High-grade steel	



Retention elements

	Page	Implant	Material
Activatable friction cylinder	60	Friction	Titanium / POM
Stud fixator	61	Snap	Titanium / Ceramic



Screw connections

	Page	Implant	Function	Material	Screw connections	Splint connection
Security-Lock	70	X	Partially removable	Titanium / HL		X
Security-Lock Ceramic	71	X	Partially removable	Titanium		X
Security-Lock adhesive sleeve	72	X	Partially removable	Titanium		X
Friction Splint	74	X	Partially removable	Titanium / POM		X
Individual screw connections	80	X	Partially removable	Titanium	X	
Bridge-sectioning Attachment oc	77	X	Partially removable	Titanium / HL	X	
Set for screw connections	79	X	Partially removable	Titanium / HL	X	

HL = cast-on up to 1280 °C
Platinum-iridium = cast-on up to 1800 °C

Important information...

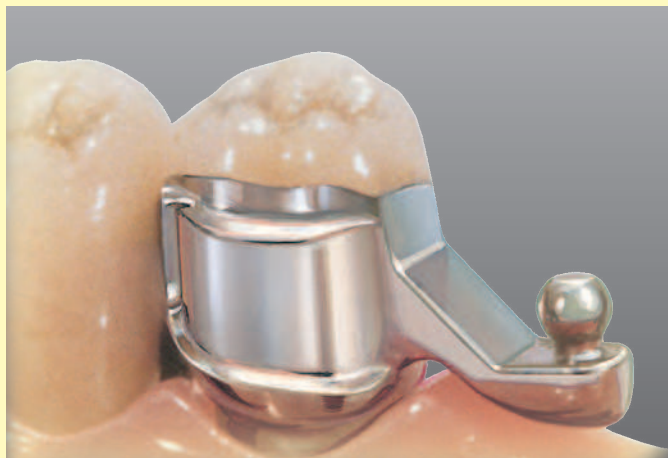

Important information for users of bredent attachments!

To ensure trouble-free and lasting function of the attachments, the stable position of the removable denture is of utmost importance. A circumferential shoulder with parallel milled interlock at the abutment crown and a corresponding shear distributor at the removable restorations are essential elements and indispensable. Kippbewegungen der Prothese müssen unbedingt vermieden werden. Tilting movements of the denture result in a high number of removal and insertion cycles of the snap attachments and - in combination with crystalline deposits - may cause premature wear and impairment to the proper function of the attachments.

bredent Research Information

Vario-Stud-Snap attachment vks oc + sg

Latest findings have shown that in a very limited number of cases deposits may be formed on natural teeth, dentures and fixed restorations in the oral environment.

If, due to insufficient oral hygiene, these crystals are not removed, some exceptional cases of inclusion of these crystals in the surface of the plastic matrix might result. This leads to an abrasive effect on the stud of the matrix resulting in the possible loss of snap. Very rare cases of this unexplained and previously unknown phenomenon have been reported for the Stud-Snap attachments sold (1 of 5000 patients).

Accordingly, we recommend the exclusive use of hard alloys and to clean the teeth, the denture and the fixed restoration two times a day as well as to have them regularly checked by the dentist. To ensure perfect function of the Vario-Stud-Snap attachment it is necessary that the patient acquires the snap point with his finger when inserting the denture and locks it by pressing on it with his finger.

Interlock

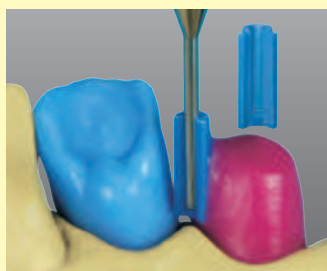
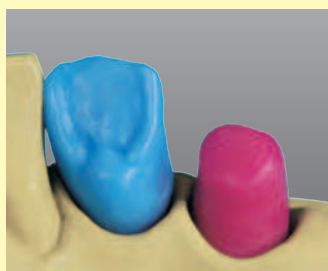

Parallel- and 2°-Interlock made of high-melting special wax.

After determining the direction of insertion, the copings are produced (wax or resin).

- Fast and reliable attaching of the Interlock
- No damage to the die when drilling the Interlock
- Only drill with a groove bur
- Defined wall thickness of just 0.4 mm

The Interlock is integrated into the model using the paralleling mandrel. Then the circular groove is modelled and milled.

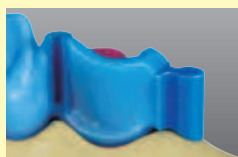

Fast and correct attaching of the Interlock with shear distributor ensures quick reworking.

Interlock parallel

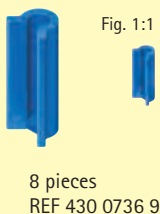

Paralleling mandrel Interlock, parallel

1 piece
REF 360 0116 6

Interlock 2°

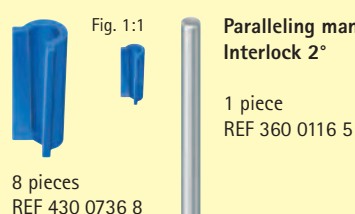

Paralleling mandrel Interlock 2°





1 piece
REF 360 0116 5

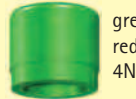

Vario-Kugel-Snap vks-oc Overview of products

Matrix housing and matrices

<p>Fig. 1:1</p>  <p>Metal matrix housing vks-oc 1,7 2 pieces REF 430 0697 0 8 pieces REF 430 0661 0</p>	<p>Fig. 1:1</p>  <p>Matrix housings vks-oc 1,7 REF 430 0699 0 vks-oc 2,2 REF 430 0698 0</p>	<p>Fig. 1:1</p>  <p>Blocking out discs vks-oc 1,7 8 pieces REF 430 0652 0 vks-oc 2,2 12 pieces REF 430 0540 0 50 pieces REF 430 0653 0 50 pieces REF 430 0548 5</p>
<p>Fig. 1:1</p>  <p>green - reduced snap, 4N vks-oc 1,7 8 pieces REF 430 0655 0 vks-oc 2,2 8 pieces REF 430 0654 0</p>	<p>Fig. 1:1</p>  <p>yellow - regular snap, 6N vks-oc 1,7 REF 430 0659 0 vks-oc 2,2 REF 430 0545 0 REF 430 0658 0 REF 430 0549 0</p>	<p>Fig. 1:1</p>  <p>red - high snap, 8N vks-oc 1,7 REF 430 0656 0 vks-oc 2,2 REF 430 0546 0 REF 430 0657 0 REF 430 0548 3</p>
<p>Fig. 1:1</p>  <p>Matrix housings vks-oc rs 2,2 mm for glueing or laser-welding 2 pieces REF 440 0020 2 8 pieces REF 440 0020 8</p>	<p>Fig. 1:1</p>  <p>Matrix housing for fixation in acrylics vks-oc rs Ø 2,2 mm REF 440 0030 2 REF 440 0030 8</p>	

<p>Fig. 1:1</p>  <p>green - reduced snap, 4N vks-oc rs Ø 2,2 mm 8 pieces REF 440 0070 8 50 pieces REF 440 0075 0</p>	<p>Fig. 1:1</p>  <p>yellow - regular snap, 6N vks-oc rs 2,2 REF 440 0080 8 REF 440 0085 0</p>	<p>Fig. 1:1</p>  <p>red - high snap, 8N vks-oc rs 2,2 REF 440 0090 8 REF 440 0095 0</p>	<p>Fig. 1:1</p>  <p>Blocking out discs vks-oc 2,2 REF 440 0010 8 REF 440 0015 0</p>
---	--	---	--

Patrices

<p>Fig. 1:1</p>  <p>Also available digitally!</p> <p>vks-oc/sg 1,7 8 pieces REF 430 0676 0 50 pieces REF 430 0675 0</p>	<p>Fig. 1:1</p>  <p>vks-oc/sg 2,2 REF 430 0538 0 REF 430 0550 0</p>	<p>Fig. 1:1</p>  <p>vks-oc 1,7 30° REF 430 0734 5 REF 430 0734 6</p>	<p>Fig. 1:1</p>  <p>Also available digitally!</p> <p>Stud-head screw vks-oc/sg 1,7 titanium 1 piece REF 450 0005 6</p>	<p>Fig. 1:1</p>  <p>vks-oc/sg 2,2 titanium 1 piece REF 450 0004 7</p>
<p>Fig. 1:1</p>  <p>vks-oc uni 1,7 HL 2 pieces REF 430 0701 0</p>	<p>Fig. 1:1</p>  <p>vks-oc uni 2,2 HL 2 pieces REF 430 0700 0</p>	<p>Fig. 1:1</p>  <p>vks-oc 1,7 60° 8 pieces REF 430 0734 7 50 pieces REF 430 0734 8</p>	<p>Fig. 1:1</p>  <p>Thread sleeve vks-oc 1,7 HL 1 piece REF 450 0005 4</p>	<p>Fig. 1:1</p>  <p>vks-oc 2,2 HL 1 piece REF 450 0004 6</p>
	<p>Fig. 1:1</p>  <p>vks-oc 2,2 8 pieces REF 430 0539 0 50 pieces REF 430 0556 0</p>	<p>Fig. 1:1</p>  <p>vks-oc 1,7 platinum-iridium 1 piece REF 450 0005 5</p>	<p>Fig. 1:1</p>  <p>vks-oc 1,7 platinum-iridium 1 piece REF 450 0005 3</p>	

HL = cast-on up to 1280 °C
Platinum-iridium = cast-on up to 1800 °C



Vario-Kugel-Snap vks-oc uni



Rigid matrixes for fixation in an acrylic denture.

For root caps and bars.

vks oc uni in burnout plastic are cast together with the root cap. They can be processed easily and are particularly biocompatible since there is no electrochemical potential difference caused by a different alloy.

vks-oc uni are also available in a cast-on, high-melting alloy. They are particularly precise since reworking after casting is no longer required.

Root cap variation – Polymerization



Root cap is modeled in the usual way. Bring the vks-oc uni into the correct position using the paralleling mandrel and fix with hot wax.



Remove paralleling mandrel and apply rich coat of hot wax onto the transition zone of vks-oc uni/root cap. The one-piece casting facilitates processing.



Casting is carried out according to standard criteria. After casting, the vks-oc unit is only slightly polished to high lustre using a textile buff.



The blue blocking out disc is placed onto the matrix below the equator. Plug the plastic matrix into the metal matrix housing using the inserting instrument.

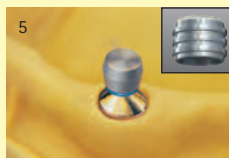

Press the metal matrix housing with the plastic matrix onto the matrix. The blocking out disc ensures parallel position of the matrix.



For try-in, fix the metal matrix at the acrylic base plate using a small amount of acrylic.

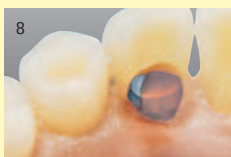

Matrix housing in the set-up. The picture shows that only little space is required. For try-in, remove the blocking out discs.



For completion, place on the blocking out disc and cover root cap with liquid silicone. Do not cover the occlusal part of the stud.



Press the metal matrix housing with integrated plastic matrix into the silicone that is still soft.

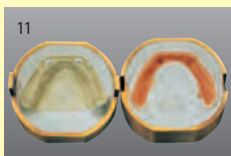

The denture is completed in the usual way after the silicone cover has hardened.

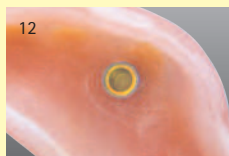

The completed restoration from the basal view. To change the snap, remove the integrated plastic matrix using a round bur and insert a different plastic matrix.

Bar variation

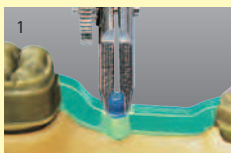

Place a vks-oc uni in the correct position on a completely waxed-up bar using the paralleling mandrel and fix with hot wax.



Remove paralleling mandrel and apply wax onto the transition zone of vks-oc uni/wax bar.



Casting is carried out in the usual way. vks-oc uni is only slightly polished to high lustre using a textile buff.



Vario-Kugel-Snap vks-oc uni



Use on root caps for fixation in the CoCr structure.

Root cap variation – Luting in



1 Root cap is modelled in the usual way. Bring the vks-oc uni into the correct position using the paralleling mandrel and fix with hot wax.



2 Remove paralleling mandrel and apply rich coat of hot wax onto the transition zone of vks-oc uni/root cap. The one-piece casting facilitates processing.



3 Casting is carried out according to standard criteria. After casting, the vks-oc unit is only slightly polished to high lustre using a textile buff.

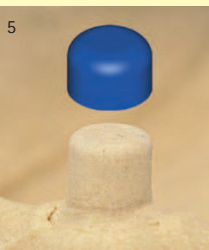

4 Fill undercuts between the blocking out disc and the marginal line with blocking out wax and block out and duplicate the chrome cobalt framework in the usual way.

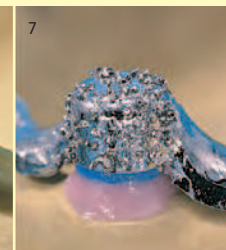

5 In order to wax up the chrome cobalt framework over the matrix housings, use the special wax matrix housings. They ensure correct thickness of the chrome cobalt frame. Complete the chrome cobalt framework in the usual way.

Assortment

Vario-Stud-Snap vks universal 1.7

- 14 pieces
 - 2 Matrices each red, yellow, green
 - 2 Metal matrix housings
 - 2 Blocking out discs
 - 2 Patrices
 - 1 Matrix inserting instrument
 - 1 Paralleling mandrel
- REF 430 0674 0

Assortment

Vario-Stud-Snap vks universal 2.2

- 14 pieces
 - 2 Matrices each red, yellow, green
 - 2 Metal matrix housings
 - 2 Blocking out discs
 - 2 Patrices
 - 1 Matrix inserting instrument
 - 1 Paralleling mandrel
- REF 430 0532 0

Assortment

Vario-Stud-Snap vks-oc rs 2.2

- 18 pieces
 - 2 Rigid matrices each, red, yellow, green
 - 2 Matrix housings
 - 2 Duplicating matrix inkl. 2 Matrices yellow
 - 2 Wax matrix housing
 - 2 Blocking out discs
 - 2 Patrices
 - 1 Matrix inserting instrument
 - 1 Paralleling mandrel
- REF 440 0001 0



Vario-Kugel-Snap vks-oc – extracoronal use



The extracoronal vks-oc must always be used in conjunction with a milled shear distributor. This way optimal transfer of resulting forces onto the anchor tooth is ensured.

vks-oc is available in two different angles to allow optimal adaptation to the course of the gingiva.

vks-oc Ø 1.7 mm and vks-oc Ø 2.2 mm: assembly in chrome cobalt framework

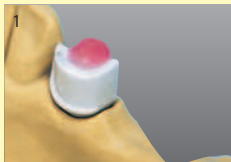

At the beginning a crown is waxed up in the usual way and a milled shear distributor with groove is prepared in wax.



Select the suitable vks-oc according to the course of the papillae and bring it into the correct position using the paralleling mandrel.

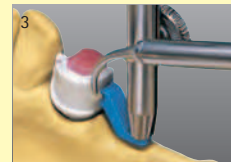

Fix vks-oc at the crown using hot wax.



The transition zone of vks-oc/crown must be coated richly with hot wax. vks-oc patrices consist of burnout plastic. They are cast together with the crowns.



The one-piece castin facilitates processing. After casting, the vks-oc is only slightly polished to high lustre using a buff.

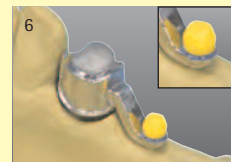

The extracoronal vks-oc patrices are assembled in the chrome cobalt framework in a very easy manner.

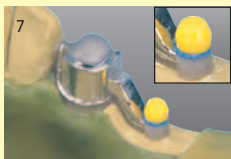

Block out to the basal direction starting from the blocking out disc. This way the perfect recess in the chrome cobalt framework to hold the matrix is obtained.

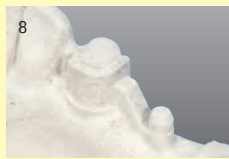

Then produce duplicate with chrome cobalt investment material.

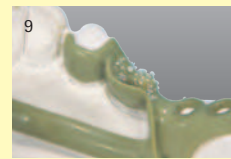

Wax pattern of the planned chrome cobalt supply: the matrix is coated with a wax layer (thickness approx. 0.4 mm).



The completed chrome cobalt framework is ready for the assembly of the matrix with the inserting instrument.



The matrix is mounted with the special inserting instrument. Retention is ensured due to the conical outer shape. To exchange the matrix use a round bur or the matrix pliers.

Assortment

22 pieces

Vario-Stud-Snap vks-oc 1.7 30°/60°

4 Blocking out discs oc 1.7

1 Inserting instrument vks 1.7

4 Matrices oc 1.7 each - yellow, green, red

1 Paralleling mandrel metal ph-vks 1,7

2 Patrices oc 1.7 each 30° + 60°

REF 430 0734 9

Assortment

12 pieces

Vario-Stud-Snap vks-oc 2.2

2 Blocking out discs oc 2.2

1 Inserting instrument vks 2.2

2 Matrices oc 2.2 each - yellow, green, red

2 Patrices oc 2.2

1 Paralleling mandrel metal ph-vks 2.2

REF 430 0531 0

Assortment

10 pieces

Vario-Stud-Snap vks-oc 2.2

2 Blocking out discs oc 2.2

2 Matrices oc 2.2 each - yellow, green, red

2 Patrices oc 2.2

REF 430 0534 0



Vario-Kugel-Snap vks-oc exchangeable stud

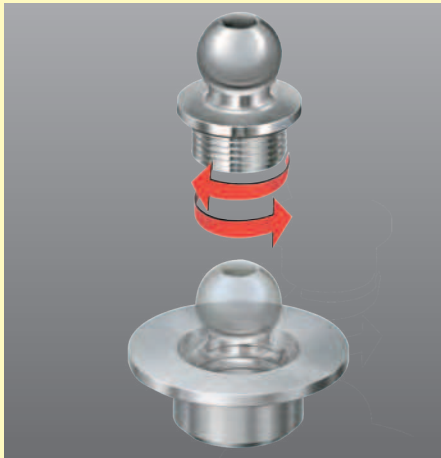

Safety, precision and biocompatibility due to easily exchangeable titanium stud.



1 The stud-head screw is only slightly screwed into the thread sleeve and held to the root cap wax-up using the paralleling mandrel.



2 The attachment matrix is waxed to the wax model in the determined path of insertion.

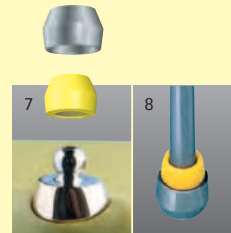

7 Processing is continued using vks-oc 2.2 mm rigid matrices



3 The stud-head screw is turned out (anticlockwise) of the thread sleeve using the screwdriver.



4 Prior to investing the model, the stud-head screw must be replaced by the fixation screw.



5 Colloid graphite is applied onto the thread area of the fixation screw; then the screw is turned into the thread sleeve exerting minimum force.



6 The casting is sandblasted and the fixation screw is turned out. The root cap is finished, the stud-head screw turned in and polished to high lustre using titanium polishing paste.

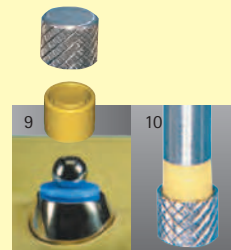

9 or vks-oc rs 2.2 mm rigid matrices.

Assortment

vks-oc 1.7 exchangeable stud
5 pieces
1 Stud-head screw
1 Thread sleeve

1 Fixation screw
1 Screwdriver
1 Paralleling mandrel
REF 450 0005 8

Assortment

vks-oc 2.2 exchangeable stud
5 pieces
1 Stud-head screw
1 Thread sleeve

1 Fixation screw
1 Screwdriver
1 Paralleling mandrel
REF 450 0004 5



Ball attachments

Vario-Kugel-Snap vks-oc/sg exchangeable stud with adhesive sleeve

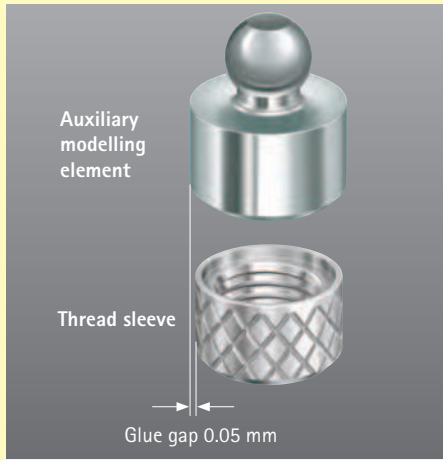

One auxiliary modelling element for oc and sg.

The glue-in titanium thread sleeve as a low-cost alternative to the cast-on thread sleeve.

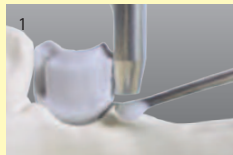

The auxiliary modelling element is integrated with the paralleling mandrel into the model according to the path of insertion.

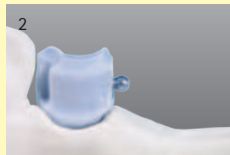

The shape of the auxiliary modelling element allows to recognize the final alignment of the attachment.



Remove the auxiliary modelling element prior to investing.



After polishing, turn the stud-head screw into the thread sleeve and glue in the sandblasted seating using DTK adhesive.



Place the matrix on the stud-head screw and continue processing in the usual way.



Processing of vks-oc is carried out using the same auxiliary modelling element.



Fig. 1:1 **Auxiliary modelling element 1.7**
1 piece REF 450 0007 3



Fig. 1:1 **Auxiliary modelling element 2.2**
1 piece REF 450 0007 5



Fig. 1:1 **Thread sleeve titanium 1.7**
2 pieces REF 450 0007 4

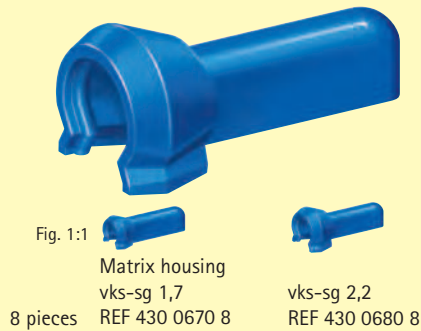

Fig. 1:1 **Thread sleeve titanium 2.2**
2 pieces REF 450 0007 6



Vario-Kugel-Snap vks-sg Overview of products

Matrix housing



Matrices

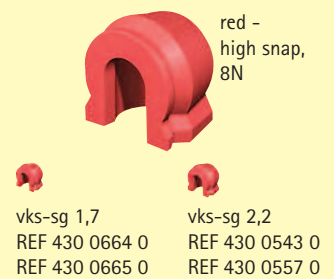
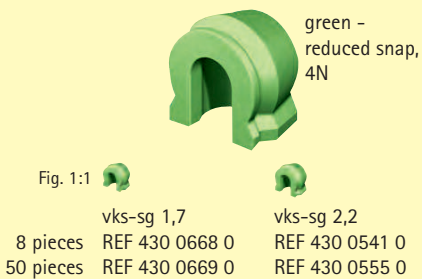

Patrices

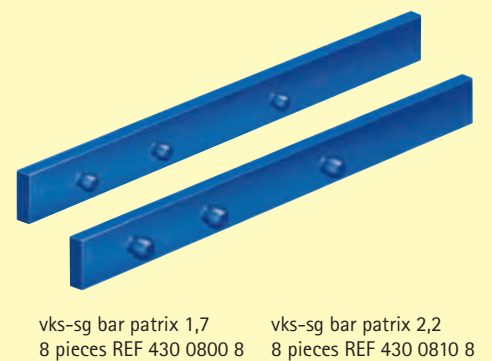
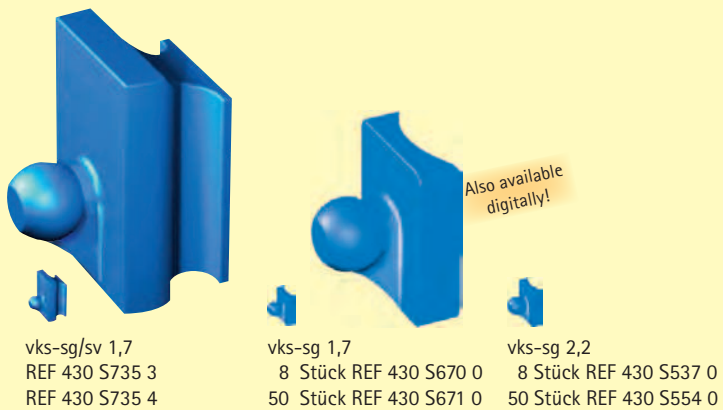
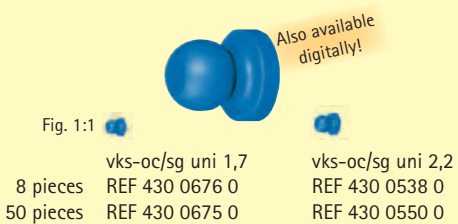

HL = cast-on up to 1280 °C
Platinum-iridium = cast-on up to 1800 °C



Vario-Kugel-Snap vks-sg sv

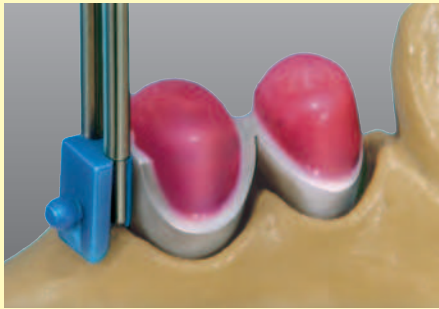

Shear distributor vks-sg/sv 1.7

sg/sv 1.7 matrix with a completely new snap-in attachment including a shear distributor with 1.7 mm stud. No additional shear distributor required.



1 The secondary element with the matrix pressed in ensures a permanent snap.

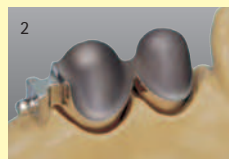

2 After casting, the stud and friction surfaces must not be trimmed.

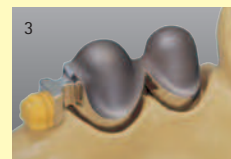

3 The surfaces polished to high gloss provide the perfect precondition for precise fit of the snap matrix.

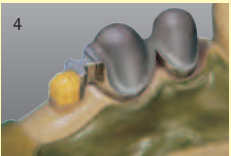

4 The model must always be duplicated with the yellow matrix in position. This way the perfect housing for individual adjustment of the snap is obtained.

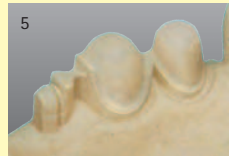

5 The investment model can be cast using standard methods.

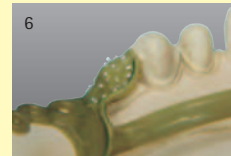

6 The precisely reproduced matrix is integrated into the pattern.

If the vks attachment is to function perfectly it is essential that the patient finds the "snap-in spot" with the fingers and presses on the restoration to lock it into place.

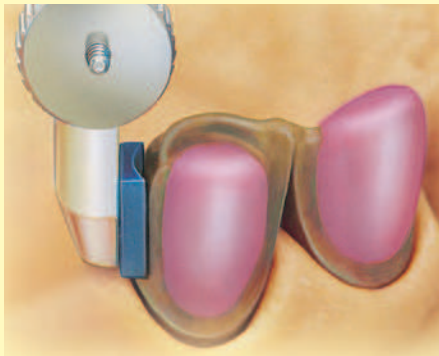

vks-sg for free-end dentures



sg matrix
The concave waxing surface and mirror-finish on the resin provide the best possible conditions for producing precise castings.



1 The concave waxing surface on the sg matrix permits it to be fitted in close proximity to the crown.



2 The diameter of the stud must not be modified.



3 No spacer wax should be applied beneath the matrix during blocking out so that the matrix can be fully enveloped in metal.



4 The framework pattern must cover the matrix completely.



5 Trim the chrome cobalt framework as usual and fit it down. Coat the matrix housing with wax when polishing the framework.



6 The matrix with the desired snap is integrated with the insertion pin.



Vario-Kugel-Snap vks-sg

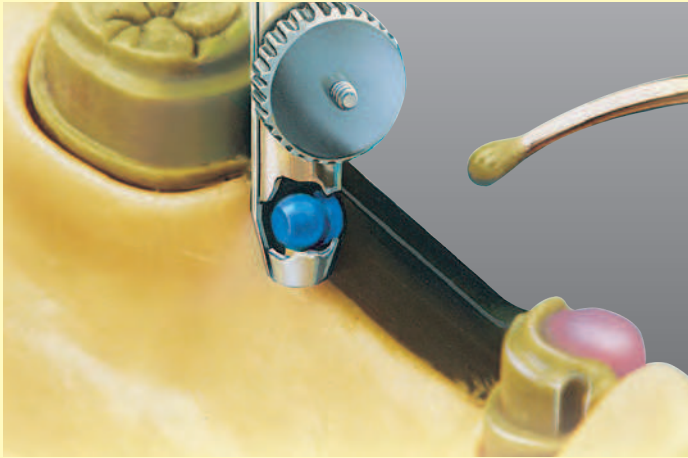

For custom applications



1 Once the cost-effective, one-piece casting has been completed, it can be blocked out for duplicating.



2 The investment model must be fabricated using a yellow matrix.



3 The bar and matrix are simply coated with wax. The remaining sections of the pattern should be waxed up as required.

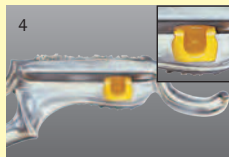

4 The Vario-Stud-Snap sg retains every type of denture securely. The dentist is able to select the correct snap for each individual patient.

Assortments

vks assortment	35 pieces	REF 430 0530 0
vks assortment sg/uni 1,7	25 pieces	REF 430 0651 0
vks assortment sg/2,2	10 pieces	REF 430 0533 0
vks assortment sg 1,7	10 pieces	REF 430 0673 0
vks assortment sg/sv 1,7	9 pieces	REF 430 0735 2



Vario-Kugel-Snap vks-sg matrix housing

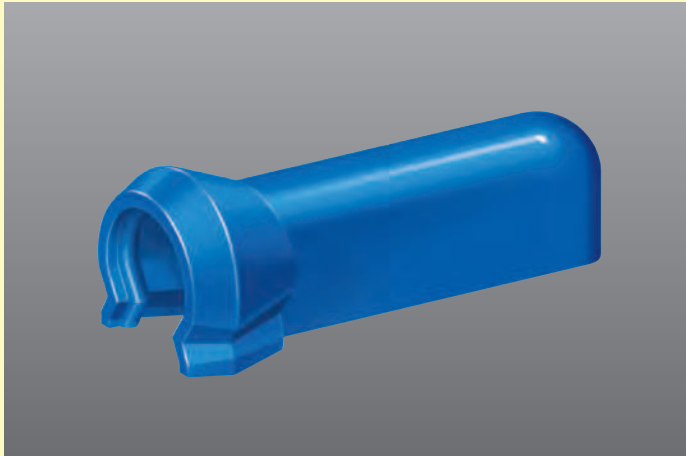

The matrix housing ensures reliable hold of the matrix and simultaneously allows to obtain a stress-free CoCr structure thanks to glueing.



1 Prepare the crown in the usual way.

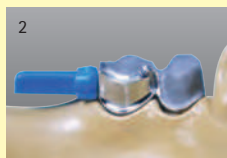

2 Insert the green matrix into the plastic matrix housing and place it on the stud matrix.

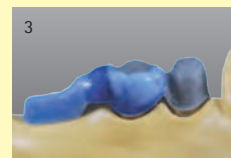

3 Use Pi-Ku-Plast for modelling the shear distributor and connect it with the matrix housing. Remove the matrix prior to casting.



4 Sandblast the appendix before glueing and attach retentions.



5 Use DTK adhesive to glue matrix housing and CoCr structure together.

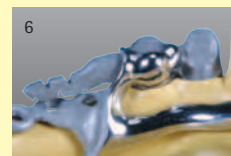

6 The appendix can also be polymerized directly into the plastic saddle. A shear distributor is always required.



Vario-Kugel-Snap vks-sg bar patrix

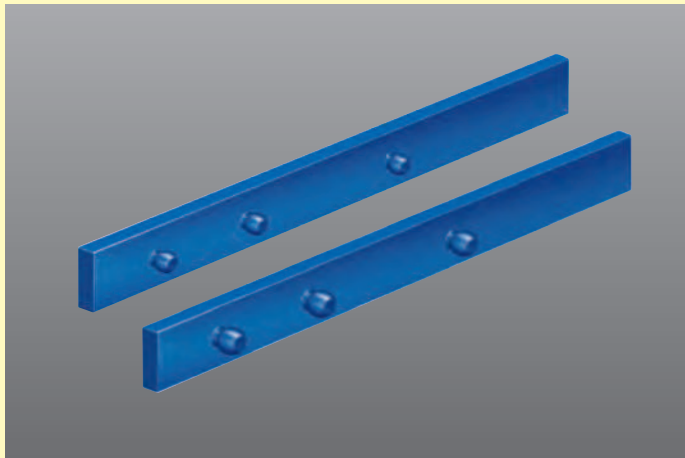

Vario-Stud-Snap bar patrix.

Bar element with three integrated vks-studs in the sizes 1.7 or 2.2 mm.



Time is saved during waxing up thanks to the integrated vks studs. The bar is cut to the proper length using a separating disc and fitted into the gap.



Use paralleling mandrel for waxing up the bar patrix to the crowns according to the direction of insertion.



The cast bar and any undercuts below the matrix are blocked out (filled) with wax.



The bar and the matrix are simply coated with wax. The remaining sections of the pattern should be waxed up as required.



The chrome cobalt framework is fitted down and polished to high lustre using Brepol.

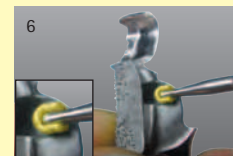

Use the inserting instrument to press the corresponding matrix in the housing.

Assortment

vks-sg bar patrix 1.7	1 Matrix inserting instrument
13 pieces	
3 Matrices each	1 Paralleling mandrel
green, yellow, red	REF 430 0806 0
2 Bar patrices	

Assortment

vks-sg bar patrix 2.2	1 Matrix inserting instrument
13 pieces	
3 Matrices each	1 Paralleling mandrel
green, yellow, red	REF 430 0816 0
2 Bar patrices	



Ball attachments

Vario-Kugel-Snap vks-sg exchangeable stud

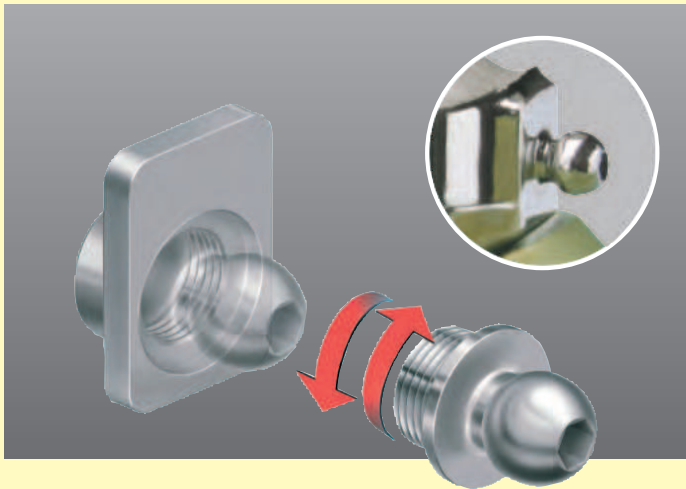

Cast-on thread sleeve and exchangeable titanium stud for precision, biocompatibility and reliability.



1 The stud-head screw is only slightly screwed into the thread sleeve and held to the wax model using the paralleling mandrel.



2 The attachment matrix is waxed to the wax model in the path of insertion of the shear distributor with parallel interlock.



3 The stud head screw is turned out (anticlockwise) of the thread sleeve using the screwdriver.



4 The stud head screw is turned out (anticlockwise) of the thread sleeve using the screwdriver.



5 Colloid graphite is applied onto the thread of the fixation screw; then the screw is turned into the thread sleeve exerting minimum force.



6 The casting is sandblasted and the fixation screw is turned out. The crowns are finished and the stud-head screw is turned in.



7 The stud-head screw is polished to high lustre using titanium polishing paste.



8 The yellow matrix is placed on the stud and the model is prepared for duplicating. Further processing with the Vario-Stud-Snap vks-sg.

Assortment

vks-sg 1.7	
exchangeable stud	1 Fixation screw
5 pieces	1 Screwdriver
1 Stud-head screw	1 Paralleling mandrel
1 Thread sleeve	REF 450 0006 1

Assortment

vks-sg 2.2	
exchangeable stud	1 Fixation screw
5 pieces	1 Screwdriver
1 Stud-head screw	1 Paralleling mandrel
1 Thread sleeve	REF 450 0004 9



Vario-Kugel-Snap vks-oc/sg exchangeable stud with adhesive sleeve

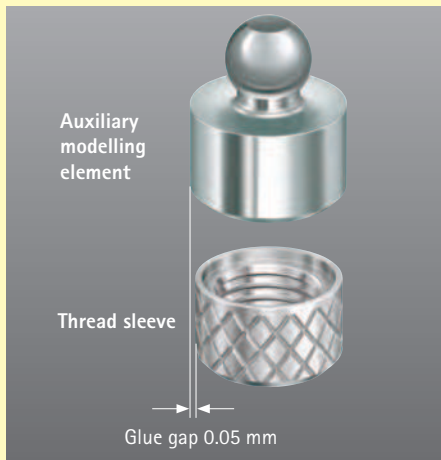

One auxiliary modelling element for oc and sg.

The glue-in titanium thread sleeve as a low-cost alternative to the cast-on thread sleeve.



1 The auxiliary modelling element is integrated with the paralleling mandrel into the model according to the path of insertion.

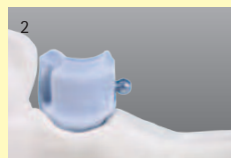

2 The shape of the auxiliary modelling element allows to recognize the final alignment of the attachment.



3 Remove the auxiliary modelling element prior to investing.



4 After polishing, turn the stud-head screw into the thread sleeve and glue in the sandblasted seating using DTK adhesive.



5 Place the matrix on the stud-head screw and continue processing in the usual way.



6 Processing of vks-oc is carried out using the same auxiliary modelling element.



Fig. 1:1 **Auxiliary modelling element 1.7**
1 piece REF 450 0007 3



Fig. 1:1 **Auxiliary modelling element 2.2**
1 piece REF 450 0007 5



Fig. 1:1 **Thread sleeve titanium 1.7**
2 pieces REF 450 0007 4



Fig. 1:1 **Thread sleeve titanium 2.2**
2 pieces REF 450 0007 6



Vario-Kugel-Snap vks-oc/sg

Accessories



vks Paralleling mandrel oc/sg
1 piece
ph-vks 1,7 REF 430 0677 0
ph-vks 2,2 REF 360 0113 0



Insertion pin
vks-oc/sg Ø 1.7 mm
1 piece REF 430 0621 0

Wax bars

Wax bars wstg 1,6
1,6 x 8 x 50 mm
ca. 65 pieces
REF 430 0265 0



Wax bars wstg 1,9
1,9 x 4 x 50 mm
ca. 120 pieces
REF 430 0266 0

Wax bars wstg 2,2
2,2 x 6 x 50 mm
ca. 65 pieces
REF 430 0267 0



Paralleling mandrel universal 2
vks-oc rs Ø 2,2 mm
1 piece REF 360 0116 0



Insertion pin
vks-oc Ø 2.2 mm
1 piece REF 430 0548 0



Paralleling mandrel for wax bars 1,9 - 2,2
for wstg 1,9 - 2,2
1 piece REF 430 0270 0



Matrix inserting instrument
vks-oc rs Ø 2.2 mm
1 piece REF 360 0116 1



Paralleling mandrel 1,6
1 piece
REF 430 0623 0

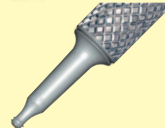

Matrix pliers
vks-oc Ø 2.2 mm + zg
1 piece REF 310 0000 6

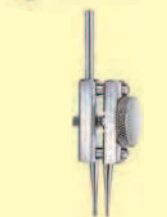

Paralleling mandrel universal
for vks-sg/sv
REF 360 0115 1



Metal transfer patrices
vks-oc/sg Ø 1.7 mm
8 pieces REF 430 0662 0



Metal transfer patrices
vks-oc Ø 2.2 mm
8 pieces REF 430 0548 2

Vario-Kugel-Snap vks-oc/sg exchangeable stud

Accessories



Screwdriver
short, hexagon
1 piece REF 330 0069 0



Tap vks exchangeable stud 1.7
1 piece REF 460 0011 7



Matrix adhesive assortment
REF 540 0103 1



Screwdriver
Stud-head screw
vks oc/sg 1,7
1 piece REF 330 0116 4



Tap vks exchangeable stud 2.2
1 piece REF 460 0012 2



Assortment - DTK-adhesive
1 x 8 g double-mix cartridge
DTK-adhesive
10 x mixing cannula
1 x syringe piston
1 x disposable brush holder
10 x disposable brush
REF 540 0118 5

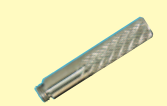

Fixation screw
M 2
1 piece REF 450 0004 8
M 1,6
1 piece REF 450 0005 7



Vario-Soft 3 Overview of products

Matrix housing and matrices

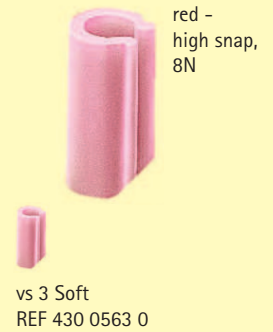
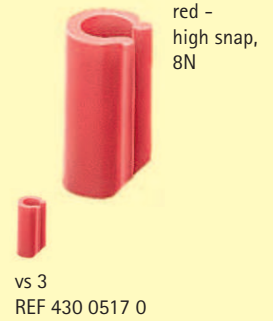
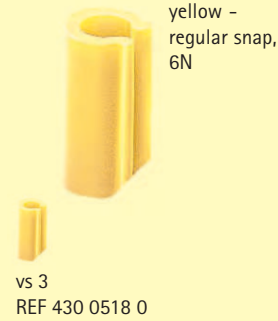
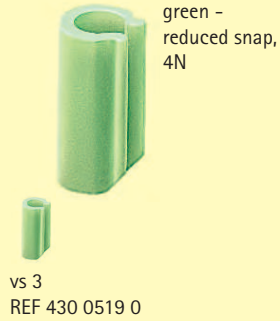
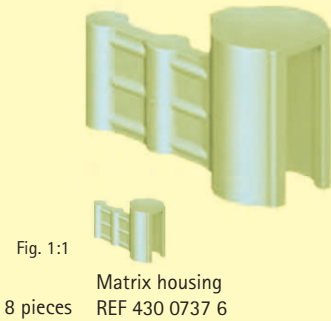

Duplicating matrix



Matrices

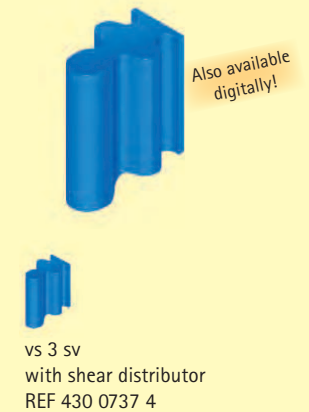
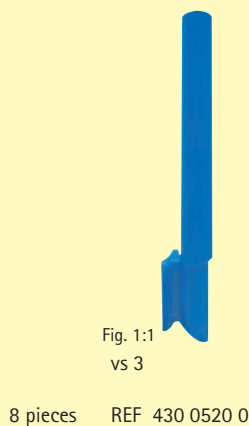



Vario-Soft 3

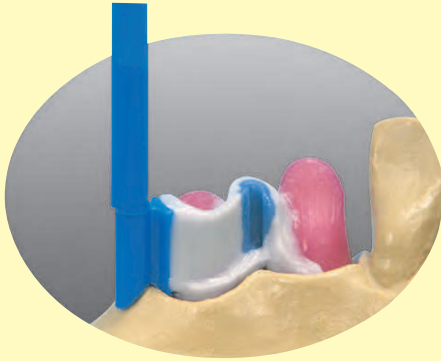

Soft matrices

Matrixes that have proved their reliability for 20 years provide safety and ensure high comfort of wear for the patient.

Soft soft matrices

Special soft plastic compensates small divergences and minor processing imperfections.

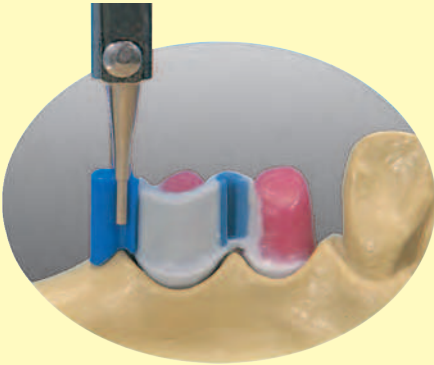

1 After casting, patrices must only be processed using rubber polishers and high-lustre buffs.



2 The white duplicating matrix that has been adapted from the basal direction provides the perfect precondition for all other types of friction.



3 Master model prepared for duplicating.

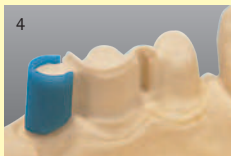

4 Wax matrix housing on the investment material model guarantees a uniform chrome cobalt housing.

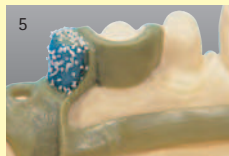

5 Completed wax pattern of the later chrome cobalt framework.



6 The use of the inserting instrument ensures precise positioning of the matrices.

Assortment

13 pieces

Vario-Soft 3

2 vs 3 Patrices

1 Matrix inserting instrument

2 Duplicating matrix

2 Wax matrix housing

2 Soft Matrices, green - reduced friction

2 Soft Matrices, yellow - regular friction

2 Soft Matrices, red - high friction

REF 430 0516 0

Assortment

13 pieces

Vario-Soft 3 without integrated paralleling mandrel

2 vs 3 Patrices without paralleling mandrel

1 Matrix inserting instrument

2 Duplicating matrix

2 Wax matrix housing

2 Soft Matrices, green - reduced friction

2 Soft Matrices, yellow - regular friction

2 Soft Matrices, red - high friction

REF 430 0738 2

Assortment

13 pieces

Vario-Soft 3 Soft

2 vs 3 Patrices

1 Matrix inserting instrument

2 Duplicating matrix

2 Wax matrix housing

2 Soft Soft Matrices, green - reduced friction

2 Soft Soft Matrices, yellow - regular friction

2 Soft Soft Matrices, red - high friction

REF 430 0561 0



Vario-Soft 3 sv

Saves time and provides perfect options for esthetic design while ensuring maximum transfer of forces.

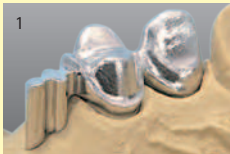
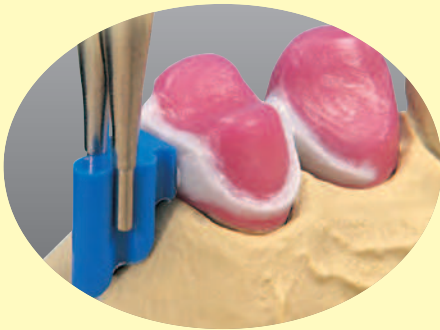

1 The matrix based on computer-aided-design includes all requirements of a modern filigree retaining element.



2 The white duplicating matrix guarantees precision-fit integration of the various friction matrices.



3 Master model prepared for the production of the investment compound model.



4 Precise investment material model ensures precision-fit integration of shear distributors.

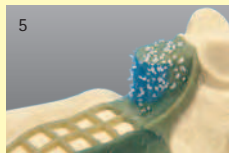

5 Due to the integrated shear distributor patient-friendly constructions that protect the periodontium can be achieved.



6 If other friction values are desired, simply exchange the matrices.

Assortment

- 13 pieces
- Vario-Soft 3 sv**
- 2 vs 3 Patrices with integrated shear distributor
- 1 Matrix inserting instrument
- 2 Duplicating matrix
- 2 Wax matrix housing
- 2 Soft Matrices, green - reduced friction
- 2 Soft Matrices, yellow - regular friction
- 2 Soft Matrices, red - high friction
- REF 430 0738 3

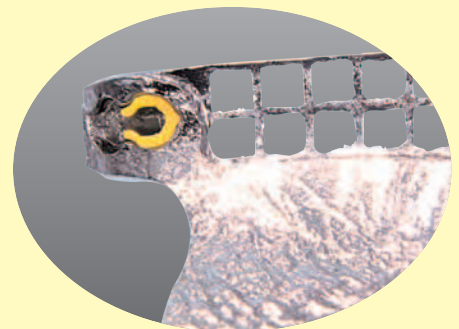



Vario-Soft 3 matrix housing

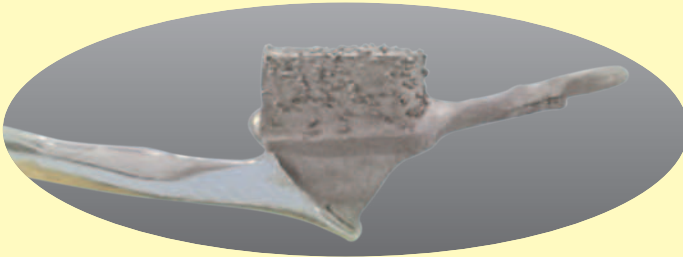

Made of plastic to produce a precision-fit metal matrix housing with any alloy.

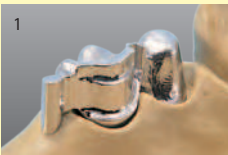
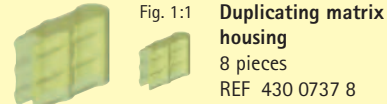

1 The matrix housing is perfectly suitable for all vs 3 patrices. The shear distributor must be integrated.



2 Slide vs 3 matrix into matrix housing and adapt to the prevailing conditions from the basal direction; then place it onto the patrix.

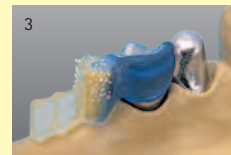

3 The shear distributor is coated with Pi-Ku-Plast modelling resin and connected to the matrix housing. Retention crystal must not be spread onto the retention area of the matrix housing.



4 Prior to investing, remove vs 3 matrix from the matrix housing and cast in the alloy of your choice.



5 After removing inaccuracies in the cast object, insert the matrix with the inserting instrument.

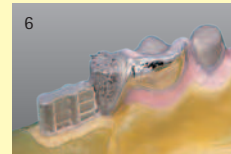

6 The duplicating matrix housing is placed onto the retention element. The defined wall thickness of 0.2 mm ensures an optimum gap for glueing.



7 The outer shape of the duplicating matrix has also been designed in a way to ensure clamping of the adhesive during glueing.

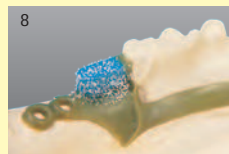

8 The wax housing is placed onto the retention appendix and connected to the chrom cobalt model.



9 Prior to glueing, vaseline is applied to the master model and the parts to be glued are sandblasted with 110 µ aluminium oxide.

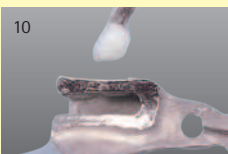

10 A thin coat of DTK adhesive is applied onto the matrix housing and the chrome cobalt framework.



11 which are then glued exerting uniform pressure.





Vario-Soft 3 mini Overview of products

Matrices

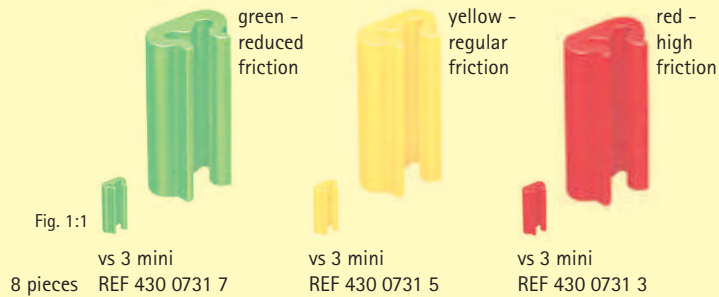

Duplicating matrix



Patrices

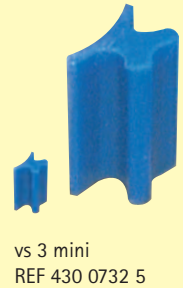

Vario-Soft 3 mini sv Overview of products

Matrices



Duplicating matrix



Patrices



Inverto Plus Overview of products

Matrices



Matrix HL suitable for casting-on
1 piece REF 450 0004 0



Matrix resin
2 pieces REF 450 0004 1

Patrices



Patric 45°
incl. activating screw,
glue-in sleeve and
basal screw
1 piece REF 450 00P4 5



Patric 90°
incl. activating screw,
glue-in sleeve and
basal screw
1 piece REF 450 00P9 0



Vario-Soft 3 mini

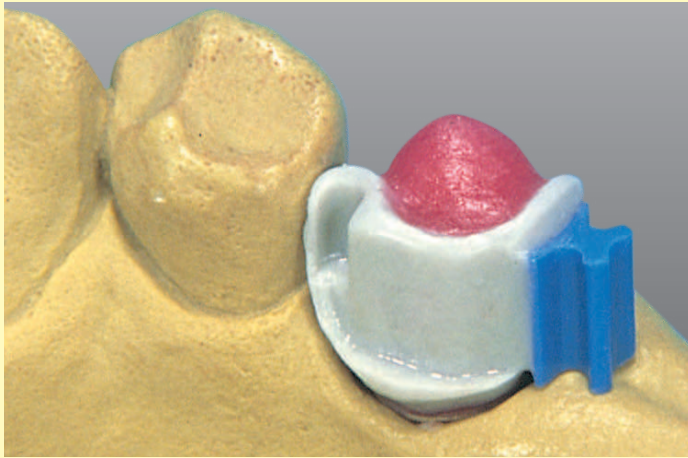

The computerized slender design and three patient-specific soft friction types provide reliable retention even in cases of limited space available.

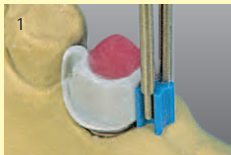

1 The slender design of the paralleling mandrel ensures safe retention and leaves sufficient space for waxing up.



2 The duplicating matrix ensures precise fabrication of the metal matrix housing in the chrome cobalt framework.

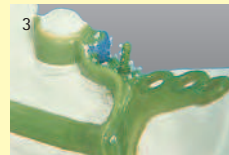

3 The working steps are carried out in the usual way. This way quality is assured.

Assortment

13 pieces

Vario-Soft 3 mini

2 Patrices

2 Duplicating matrices

2 Wax matrix housings

2 Matrices, green - reduced friction

2 Matrices, yellow - regular friction

2 Matrices, red - high friction

1 Matrix inserting instrument

REF 430 0731 2





Vario-Soft 3 mini sv

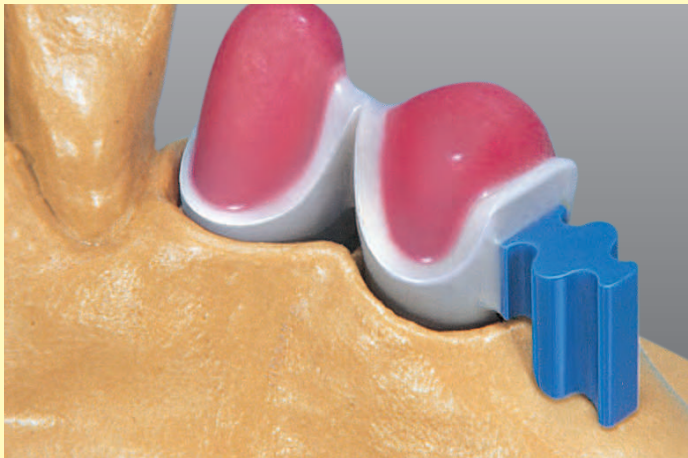

The optimized combustion behaviour of the patrix guarantees the precision in the cast object.



The duplicating matrix can be individually adapted to any situation.

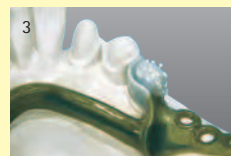

The pattern is waxed up according to standard criteria; no new techniques have to be learned.

Assortment

13 pieces

Vario-Soft 3 mini sv

- 2 Patrices
- 2 Duplicating matrices
- 2 Wax matrix housings
- 2 Matrices, green - reduced friction
- 2 Matrices, yellow - regular friction
- 2 Matrices, red - high friction
- 1 Matrix inserting instrument

REF 430 0733 0





Vario-Soft 3 conical bridge



A precisely fitting sectioned bridge is made in a time-saving, economic, tension-free way without individual milling work and independent of alloy situation and.

Bridge sectioning attachment for fixed prosthesis in case of divergent abutment teeth

- Precisely fitting, full burn-out synthetic mold parts
- Conic shape for easy processing
- Integrated parallel holder on male parts and matrix save time and expand the application range
- Designed for intra- and extra-oral use
- No individual milling work necessary
- Primary and secondary parts are fabricated simultaneously to save time and money

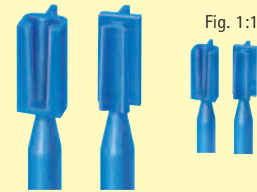

Fig. 1:1 **Vario-Soft 3** conical bridge
4 females, 4 males
REF 430 0734 0

Female and male parts are simply exchanged for intra- or extra-coronal use - any application is possible!



1 The modellation is made according to insertion direction and esthetic requirements.



2 Female and male parts are assembled and the parallel holder is taken off the not required part.



3 The existing retention and the height of the attachment are individually adjusted to the situation with a metal bur.



4 The secondary part is completed by the modellation of the bridge link. By individualizing the attachment, it adapts to any situation perfectly.

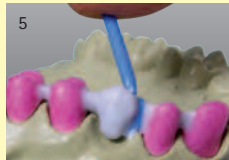

5 Simply use a finger or an instrument to remove the parallel holder at the „predetermined breaking point“.

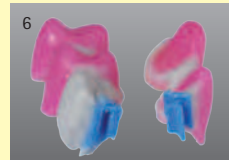

6 Primary and secondary part are mo-delled in one step - time saving, material saving, efficient.



7 The modellation is moun- ted and invested according to the bredent Casting Technique in one step. With Transfuser and Brevest Rapid 1, the slender modellation is invested easily and bubble-free.



8 Following casting, the attachment is blast-polished with 50 µm pearls. The attachment is now assembled without having to work it over elaborately.

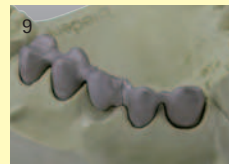

9 The attachment distinguishes itself through a special shape and precise fit. The long-lasting connection is proof for the success!

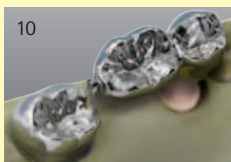

10 The integrated parallel holder allows intracoronal use of the female within the primary part.



Inverto Plus



Exchangeable, intracoronal attachment with activating screw.

Wax model

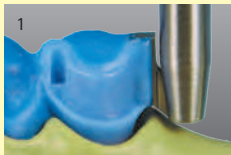

Attachment is attached to the wax model with HL or plastic matrix.

Completed casting



Finish the casting and adjust height of attachment.

Duplicating



Replace auxiliary duplicating element with glue-in sleeve and block out undercuts. Duplicate in the usual way.

Glueing in the attachment



Produce CoCr structure and glue the glue-in sleeve onto the model.

Cleaning glueing areas



Clean glueing areas and remove excess material after the adhesive has hardened.



Rod attachments

Vario-Soft 3

Accessories



Paralleling mandrel universal
for vks-sg/sv
REF 360 0115 1



Assortment - DTK-adhesive
1 x 8 g double-mix cartridge
DTK-adhesive
10 x mixing cannula
1 x syringe piston
1 x disposable brush holder
10 x disposable brush
REF 540 0118 5



Matrix inserting instrument for Vario-Soft 3
2 pieces REF 430 0736 6



Matrix inserting instrument for Vario-Soft 3 mini
2 pieces REF 430 0736 5



Matrix inserting instrument for Vario-Soft 3 mini sv
2 pieces REF 430 0736 4



Matrix adhesive assortment
REF 540 0103 1

If the plastic attachment matrix is not sufficiently retained in the chrome cobalt framework, this tested and approved adhesive system should be used.



Wax matrix housing Vario-Soft 3
8 pieces
REF 430 0521 0



Wax matrix housing Vario-Soft 3 mini
8 pieces
REF 430 0732 0

Wax matrix housing Vario-Soft 3 mini sv
8 pieces
REF 430 0733 8



Pi-Ku-Plast HP 36 resin
red
REF 540 0022 0
blue
REF 540 0021 9

Vario-Soft 3 conicalbridge

Accessories



Transfuser - for bubble-free investments
1 piece REF 390 S000 1
4 pieces REF 390 S000 4



Fissure Designer
REF B153 NF 04

Inverto Plus

Accessories



Basal screw
for 45° and 90°
1 piece REF 450 0004 4



Activating screw
for 45° type
1 piece REF 450 00A4 5



Auxiliary duplicating element, plastic
4 pieces REF 450 0004 2



Ceramic spacer
1 piece REF 450 0004 3



Glue-in sleeve
for 45° and 90°
1 piece REF 450 0005 0



Activating screw
for 90° type
1 piece REF 450 00A9 0



Paralleling mandrel universal 2
1 piece REF 360 0116 0



Vario-Soft-Bar-Pattern vsp Overview of products

Matrix housing



Matrix housing vsp-f
 8 pieces REF 430 0640 8
 50 pieces REF 430 0645 0

Matrices

For parallel bar restorations

For snap-in bar restorations

For jointed restorations

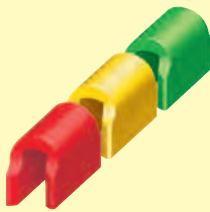

Friction matrices vsp-f
 8 pieces green REF 430 0639 0
 50 pieces green REF 430 0638 0

 8 pieces yellow REF 430 0641 0
 50 pieces yellow REF 430 0640 0

 8 pieces red REF 430 0643 0
 50 pieces red REF 430 0642 0



Friction snap-in matrices vsp-fs
 REF 430 0632 0
 REF 430 0633 0

 REF 430 0635 0
 REF 430 0634 0

 REF 430 0637 0
 REF 430 0636 0



Joint snap-in matrices vsp-gs
 REF 430 0627 0
 REF 430 0626 0

 REF 430 0629 0
 REF 430 0628 0

 REF 430 0631 0
 REF 430 0630 0

Green = reduced friction/Snap 4N
 Yellow = normal friction/Snap 6N
 Red = high friction/Snap 8N

Duplicating matrices



Duplicating matrix vsp-f
 8 pieces REF 430 0625 1
 50 pieces REF 430 0624 1



Duplicating matrix vsp-gs
 REF 430 0625 0
 REF 430 0624 0

Bars

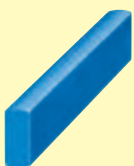

Resin bar vsp-f
 4 pieces REF 430 0647 0
 25 pieces REF 430 0646 0

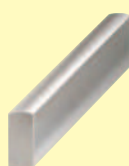

Titanium bar vsp-f
 REF 560 0001 0



Resin bar vsp-fs
 REF 430 0694 0
 REF 430 0695 0



Titanium bar vsp-fs / gs
 REF 560 0002 0



Vario-Soft-Bar-Pattern vsp-f



Parallel bar

Bar patterns made of non-distorting, fully combustible special high-tech Thermo-plast, guarantee optimum castings.

The classic parallel bar can be used for a wide range of indications.

Fabricating implant-borne restorations using a parallel bar



1 The bar should be fitted between the implant abutments with a paralleling mandrel. The bar is made of rigid acrylic which can be trimmed easily and quickly.

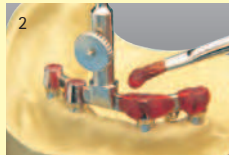

2 After casting and trimming, the bar is secured on the abutments with the paralleling mandrel. They should be soldered together to create a non-stressed unit.

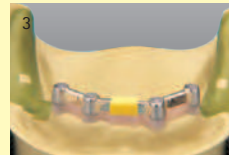

3 Duplicating is always carried out with the yellow matrix intended for the bar system. This provides the optimum conditions for changing the degree of friction later on.

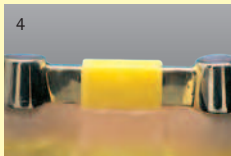

4 The restoration is blocked out and duplicated using standard methods. No spacer wax should be applied around the matrix.



5 The matrix is also duplicated and acts as a spacer for the matrix housing in the chrome cobalt framework.



6 The bar and matrix are simply coated with wax. The remaining sections of the pattern are waxed up as required.



7 Before pressing the matrix into its housing in the chrome cobalt framework, check the housing for high spots.



8 The matrix with the desired degree of friction is selected and pressed in with the inserting instrument. The additional snap-in retainers on the matrix provide optimum hold in the housing.



9 Shows the underside of the finished restoration with parallel bar and high, firm friction (red matrix). The friction can be increased or reduced as required by replacing the matrix.

Assortment

20 pieces

Vario-Soft-Bar-Pattern vsp-f, Friction

4 Matrices vsp-f each, red, yellow, green

2 Bars vsp-f

4 Duplicating matrices vsp-f

1 Paralleling mandrel metal vsp-f/fs/gs

1 Insertion pin vsp-f/fs/gs

REF 430 0650 0



Vario-Soft-Bar-Pattern vsp-fs

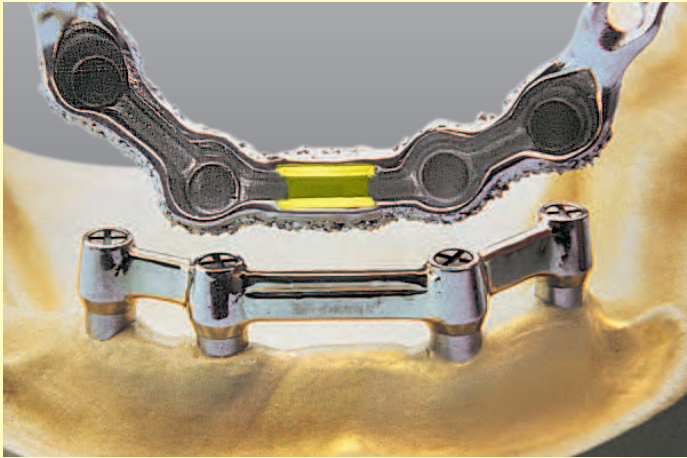

Snap-in bar

Implant in the lower jaw with a medium friction snap-in bar.

Assortment

- 18 pieces
- Vario-Soft-Bar-Pattern vsp-fs, Friction-Snap**
- 4 Matrices vsp-fs each, red, yellow, green
- 2 Bars vsp-fs
- 1 Paralleling mandrel metal vsp-f/fs/gs
- 1 Insertion pin vsp-f/fs/gs
- REF 430 0649 0

Processing, see vsp-f. The yellow matrix is used for duplicating!

Vario-Soft-Bar-Pattern vsp-gs

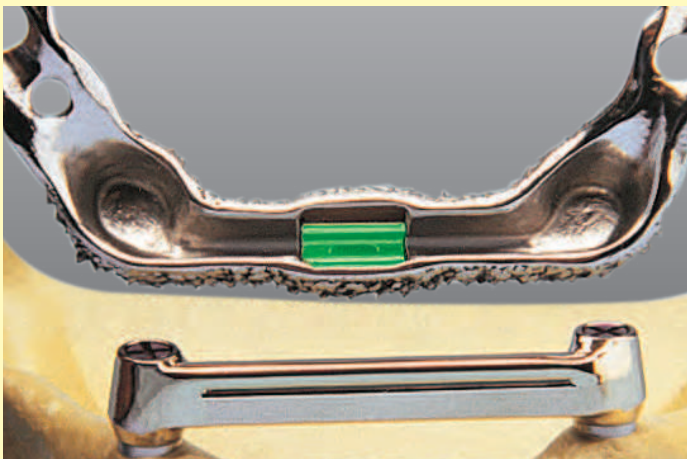

Joint bar

The special, small, replaceable snap-in jointed matrices result in optimum bar joint restorations.

Assortment

- 20 pieces
- Vario-Soft-Bar-Pattern vsp-gs, joint snap-in**
- 4 Matrices vsp-gs each, red, yellow, green
- 2 Bars vsp-gs
- 4 Duplicating matrices vsp-gs
- 1 Paralleling mandrel metal vsp-f/fs/gs
- 1 Insertion pin vsp-f/fs/gs
- REF 430 0648 0

Implant-borne restorations on jointed bars

Once the jointed bar has been soldered and trimmed, the duplicating matrix for the jointed bar snap-in matrix should be placed on it. The underside is blocked out using standard methods. To ensure that the joint matrix fits exactly, the duplicating matrix must not be coated with blocking out wax.

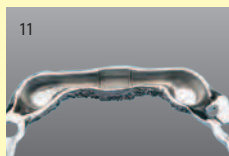
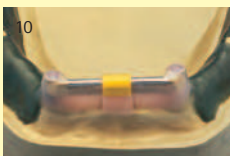

This chrome cobalt framework has been trimmed and checked for high spots and is ready to be fitted with the jointed snap-in matrix with the ideal snapping force for the patient.



The joint snap-in matrix is easily pressed into the chrome cobalt framework with the inserting instrument.

Prior to duplicating, the implant caps and the vertical bar areas are coated with a wax layer with a thickness of 0.3 mm to allow rotational movement of the denture later on. During this process, however, the rounded occlusal end of the bar must not be coated with wax.



Vario-Soft-Bar vss Overview of products

Matrices



Reduced,
light friction

vss green

8 pieces REF 430 0527 0
50 pieces REF 430 0610 0



Normal,
medium friction

vss yellow

REF 430 0526 0
REF 430 0594 0



High,
firm friction

vss red

REF 430 0525 0
REF 430 0620 0

Patrices

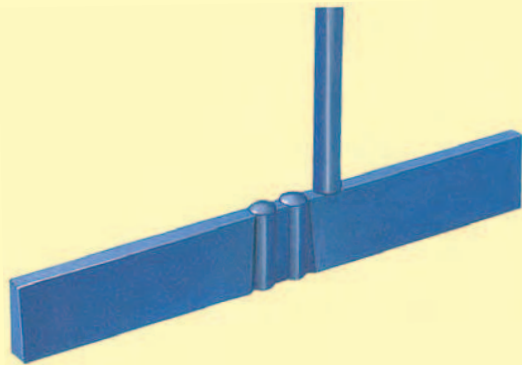

8 pieces REF 430 0524 0
50 pieces REF 430 0595 0

Bar system with three interchangeable versions with different degrees of friction. Gentle to the periodontium.

3 precision matrices with different degrees of friction.

The external dimensions of the matrices are exactly the same, which allows them to be replaced quickly to change the degree of friction

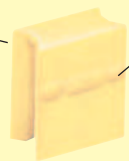

The Snap retainers guarantee retention in the matrix housing

The 4 rounded edges of the matrix create guidance grooves to retain it securely in the removable section of the denture



The double matrix technique provides for reliability

The patric of the attachment has smooth, parallel sides so that when cast correctly no trimming is required

The paralleling mandrel speeds up the working procedure

This special resin will not distort, exhibits ideal working properties and saves time

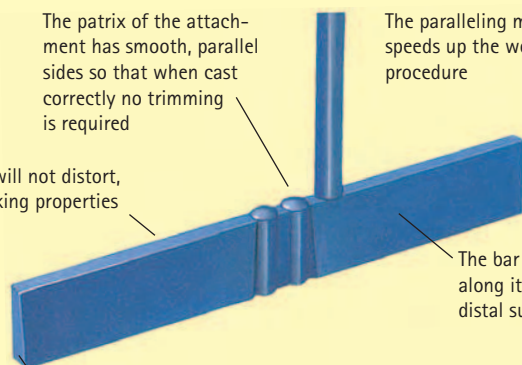

The bar patric can be reduced along its base and mesial or distal surfaces as required

The 2° taper simplifies fitting down, particularly if the removable section consists of chrome cobalt or other non-precious alloy



Vario-Soft-Bar vss

The very gentle friction will impress and enthrall you!

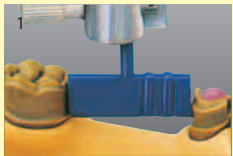

The vss bar patrx can be shortened as required, to suit any particular case. The double patrx can be positioned mesially or distally.

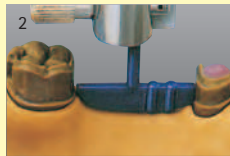

Adapt the underside of the bar to the ridge. The special resin will not distort and is easy and quick to work on.



Shows the bar patrx waxed into place. It can be adjusted with wax at any time.



As the crowns and bar are cast in one piece, no soldering is required and any alloy can be used. This makes the vss ideal for patients with allergies.



The matrix is placed over the double patrices and its underside adapted to fit. The pattern is then blocked out for the chrome cobalt framework, using standard methods.



The model is duplicated with gel or silicone and the investment model is poured. vss can be used with any investment material, thus making it unnecessary to acquire special materials.

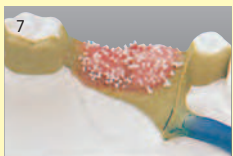

The pattern is waxed-up over the matrix reproduced in investment material. This guarantees that the chrome cobalt denture base will fit absolutely precisely.

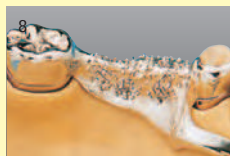

The chrome cobalt denture base is fitted down, trimmed and polished. The simple handling and gentle friction will impress you immediately.



Shows the matrix in position. Additional snap retainers guarantee optimum retention in the matrix housing.

Individually adjustable friction within reduced time and at low costs even after several years



The patrx is adapted to the situation and then waxed onto the crown. The papilla remain free, as required.



As it is cast in one piece the casting is a homogeneous structure of one alloy, which prevents stresses.



Once the yellow matrix has been fitted, block out the restoration in readiness for fabricating the chrome cobalt denture base. Ensure that no wax is applied around the matrix.



This ensures that the chrome cobalt structure reaches down to the gingiva and the matrix is retained completely in metal.



The press fit pin for the matrix is used to insert it precisely into the chrome cobalt denture base.



Thanks to the guidance grooves, the matrix fits the metal housing perfectly. It can be replaced at any time with a matrix with increased or reduced friction.

Assortment

- 2 Patrices vss
- 2 Matrices vss each - red, yellow, green
- 1 Insertion pin
- REF 430 0523 0



Bar attachments

Vario-Soft-Bar-Pattern



Insertion pin
2 pieces
REF 430 0622 0

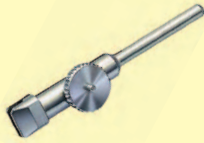

Paralleling mandrel
1 piece
REF 430 0623 0



Pi-Ku-Plast HP 36
resin
red
REF 540 0022 0
blue
REF 540 0021 9

Vario-Soft-Bar vss

Accessories



Insertion pin
REF 430 0736 3



Matrix adhesive
assortment
REF 540 0103 1

Locking Pin Easy-Snap Overview of products



Locking Pin Easy-Snap E
1 pieces REF 440 0N65 8



Locking Pin Easy-Snap A
1 pieces REF 440 0N66 0

Locking Pin Snap Overview of products

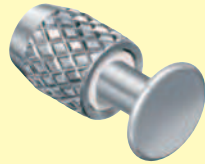

Locking Pin Snap E
1 pieces REF 440 0065 8

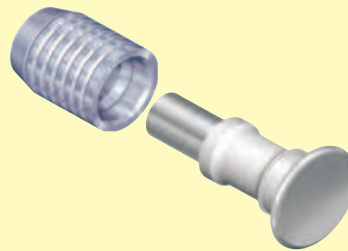

Locking Pin Snap A
1 pieces REF 440 0066 0

Locking Pin activatable Overview of products



Locking Pin activatable
2 pieces REF 430 0459 0



"mini" locking Pin activatable
2 pieces REF 430 0500 0



Locking Pin Easy-Snap System



Perfect locking pin system for secure grip of the prosthesis. Its small size permits versatile use.

- New mechanism provides secure hold for the prosthesis
- Noticeable snap when opening and closing gives patients more security
- Small size for every situation
- Can be used even in difficult locations
- Simple fitting possible in three variants

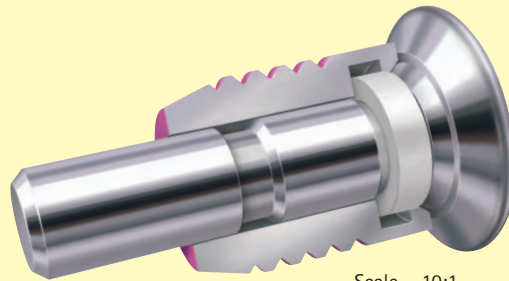

Scale = 10:1

The snap ring offers secure grip when opening and closing the locking pin axis. The simple mechanism offers the highest degree of security.

Easy-Snap E

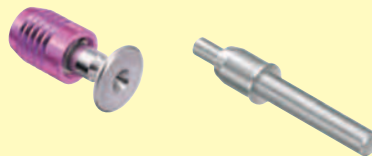

The polymerisation of the locking pin leaves all options open. Simple use for beautiful teeth!

Easy-Snap A

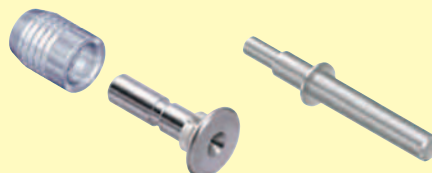

The castable variant allows for use regardless of the alloy.

Castable up to 1800°C.

Locking Pin Easy-Snap E

The primary construction is always prepared in the same manner for every application. This reduces the need for clarification and accelerates the manufacturing process.



Simple modelling of the primary construction according to the model situation. A set-up for exactly determining the position of the lock is always advantageous.



The hole is measured using the centre drill. Slipping of the Diatit multidrill is thus prevented.



Drilling is simplified using drilling and milling oil. Drill only once, as this prevents the formation of an oval hole.



The hole is closed with the wax.



The wax is removed again by hand with the Rapidy 2.0. In doing so, a slight hollow is created which positions the investment material model exactly.



The model is completely prepared for doubling. If you are working in the withdrawal procedure, omit this step.



Cast the investment material model using the bredent doubling system. The high level of design accuracy of the investment material facilitates further processing.

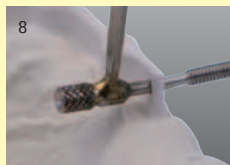

The wax guide is fixed lightly in the cast mould. The framework is modelled with a minimum thickness of 0.5 mm.



The wax guide is removed and an image is created for the locking pin.



The exit hole for the locking pin is easily recognisable on the opposite side.



The locking pin is fixed in the correct position for completion with Qu-resin.



The prosthesis is completed.



Assortment
4 pieces
Locking Pin Easy-Snap E
2 Locking Pin Easy-Snap E
2 Modelling pin E
REF 440 ON65 2

Fig. 1:1



Assortment
5 pieces
Locking Pin Easy-Snap E Model casting fitting
2 Locking Pin Easy-Snap E
2 Ceramic spacer E
1 Device for waxing-on
REF 440 ON65 3



Assortment
3 pieces
Locking Pin Easy-Snap E Plastic fitting
2 Locking Pin Easy-Snap E
1 Device for waxing-on
REF 440 ON65 1



Locking Pin Easy-Snap A



Sleeves made from platinum-iridium alloy offer time-saving processing for precious metal and non-precious metal constructions, with the exception of titanium.

For patients with less dexterity, the lock can be constructed in such a way that it can even be opened with a thin object from the buccal side. An individual stop must be fitted to this so that the lock is not opened accidentally.



The individual bridge sectioning attachment is suitable for wax modelling. Rapid modelling saves time.



Manufacturing out of brealloy enables a space-saving model to be created for an aesthetic dental prosthesis.



The position of the lock is measured using the centre drill and a small mould is fitted.



The hole is drilled for the locking pin using the Diatit-Multidrill with copious amounts of milling and drilling oil.



The small amount of space required by the Locking Pin Easy-Snap facilitates problem-free positioning of the bore hole in the male part.

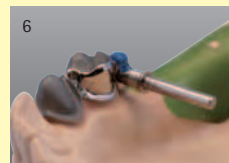

The locking pin sleeve which can be cast on, is fitted to modelling pin A and pushed into the locking hole of the patrix until it stops.

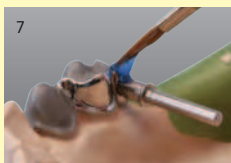

The modelling pin A with Locking Pin sleeve which can be cast on is moulded with Pi-Ku-Plast to its largest diameter.

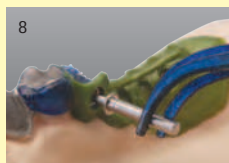

The blue clip forceps hold the modelling pin steady whilst removing this from the model. The sleeve which can be cast on remains within the model.



The modelling is carried out and cast in accordance with the bredent casting technique. The sleeve is fixed in the correct position with the investment material.



In order not to damage the sleeve which can be cast on, the investment material is blasted with glass beads. This means that it maintains its shape and performs the correct function.



The snap ring is set on the impression pin and pressed into the sleeve. It springs into its planned position.



The lock axis is then pushed in. The lock holds firm due to the mechanism and offers the patient the highest level of comfort.



Assortment
 4 pieces
 Locking Pin Easy-Snap A
 2 Locking Pin Easy-Snap A
 2 Modelling pin A
 REF 440 ON65 4

Fig. 1:1

Locking Pin Easy-Snap

Accessories



Snap ring
10 pieces
REF 440 0N66 3



Insertion pin
1 piece
REF 440 0N66 2

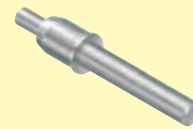

Modelling pin E
1 piece REF 440 0065 6

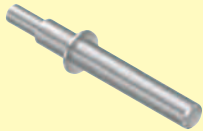

Modelling pin A
1 piece REF 440 0N65 5



Device for waxing-on
1 piece
REF 440 0066 1



Locking Pin Easy-Snap
1 piece
REF 440 0N65 9



Tungsten carbide center drill
REF 330 0066 0



Diatit-Multidril
REF 330 0073 0



Rapid Microbur
REF H001 NH 21



Milling and drilling oil
20 ml
REF 550 0000 8



Pi-Ku-Plast HP 36 resin
red
REF 540 0022 0
blue
REF 540 0021 9



FGP insulating liquid
REF 540 0102 7



Qu-resin dentin
50 ml cartridge
REF 540 0116 6

Qu-resin rosa
50 ml cartridge
REF 540 0116 5



Assortment - DTK-adhesive
1 x 8 g double-mix cartridge
DTK-adhesive
10 x mixing cannula
1 x syringe piston
1 x disposable brush holder
10 x disposable brush
REF 540 0118 5



Ceramic spacer E
2 pieces
REF 440 0065 7



Locking Pin Snap System

Suitable for numerous applications in combined work.



The soft, resin-supported guidance results in a soft snap of the locking pin during locking in the closed or open position.

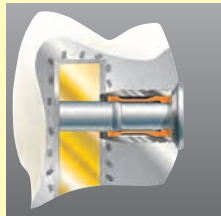

closed

The snap ensures safe locking in closed position.

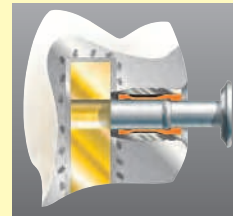

open

The snap informs the patient that the lock is completely open and the denture can be removed.

Locking Pin Snap E

The alloy is not relevant

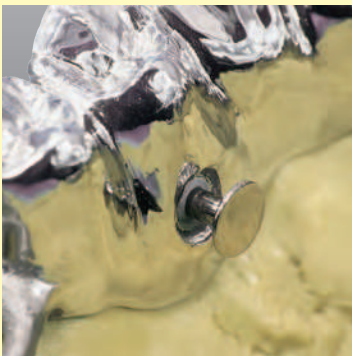

Locking Pin Snap A

Fast and precise integration in precious metal supply

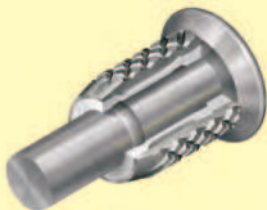
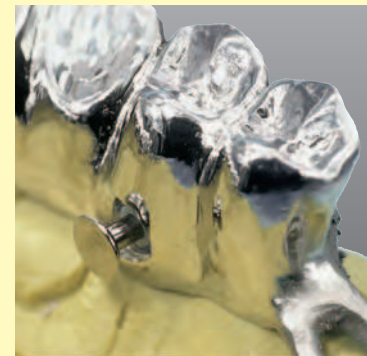

All metal parts are made of titanium. The biocompatible plastic matrix provides long service life and soft snap-friction.



Original size

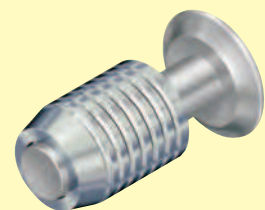

The platinum-iridium-containing alloy of the locking pin sleeve allows to save much time and ensures high precision when casting onto the metal framework.

Locking Pin Snap E

Locking Pin Snap E for integration into CoCr.

Precise integration in the one-piece casting technique



Waxing up of the pattern and casting is carried out using standard methods.



The position of the locking pin is determined with the centre drill and a small depression is prepared.



The hole for the pin is drilled with the Diatit Multidrill with a diameter of 1.5 mm.



The hole for the pin is filled with wax before duplicating.

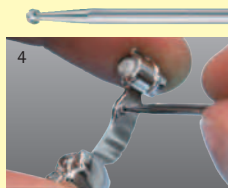

A depression is scraped on both sides using a Rapidly Microbur 2.1 mm.



The pattern is prepared for duplicating and duplicated in the usual way.

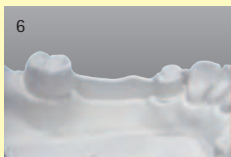

Exact reproduction of the depressions on the bar is required.



The ceramic spacer E is exactly positioned with the device for waxing on.



The ceramic spacer E is integrated into the wax pattern up to its largest diameter.



The spacer is sandblasted with a maximum grain size of 110 µ at a pressure of 4 bar.



In order to try the function, the pin is inserted into the assembled construction.

Glueing in of Locking Pin Snap E.

Contact points that must not be glued must be covered with FGP insulating liquid.



The hole in the bar and 2-3 mm in the vicinity.



The contact area of the locking pin lens at the secondary element.



The locking pin stud up to the locking pin sleeve.



The contact area of the locking pin lens at the secondary element.



Primary and secondary element are assembled. A drop of DTK adhesive is evenly spread in the hole in the secondary element.



The locking pin sleeve is covered with a thin layer of DTK adhesive and pressed into the secondary element. Excess adhesive residues are removed after hardening of the DTK adhesive.





Locking Pin Snap E

Locking Pin Snap E for integration in resin.

Easy, fast and secure integration.

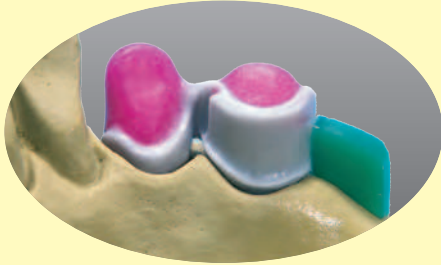

The crown is modelled with a shear distributor with interlock and the end of the bar is waxed on.

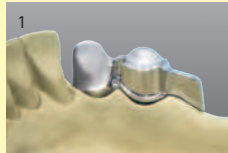

Casting and polishing are carried out after casting.

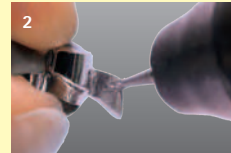

A small depression is prepared with the Diatit centre drill and in this way the position of the drillhole is determined.

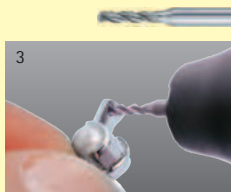

The Diatit-Multidrill is safely fixed by centering.

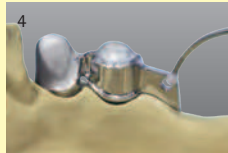

The hole for the pin is filled with wax before duplicating.

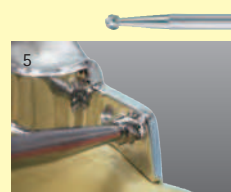

A depression is scraped on both sides of the Locking Pin matrix using a Rapidly Microbur 2.1 mm.



The pattern is prepared for duplicating and duplicated.

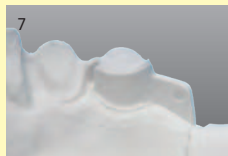

The small depressions are reproduced in the investment compound model.

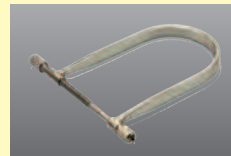

This way two round apertures are obtained on both sides.



The plugs of the device for waxing-on lock in position in the depressions.

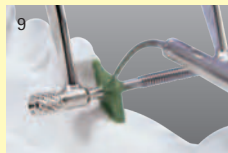

The cylindrical plugs are integrated in the pattern using modelling wax.



The Locking Pin is easily tried in.



The two apertures are parallel to the axis due to the drilled hole.



The holes are prepared using a Diatit-Multidrill with a diameter of 1.5 mm.

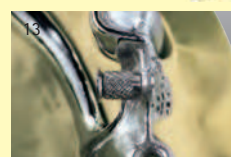

The Locking Pin lens is integrated into the wax pattern up to its outer margin and the denture is completed.



The Locking Pin is fixed to the chrome cobalt framework using resin.



Assortment

5 pieces

Locking pin snap E for integration in chrome cobalt

2 Locking Pin E

2 Ceramic spacer E

1 Device for waxing-on

REF 440 0065 3

Assortment

3 pieces

Locking pin snap E for integration in resin

2 Locking Pin E

1 Device for waxing-on

REF 440 0065 1

Locking Pin Snap E and A

When the wax pattern is lifted from the model in order to invest it, there are two options:

**Glueing in
Locking Pin Snap E**

**Casting in
Locking Pin Snap A**

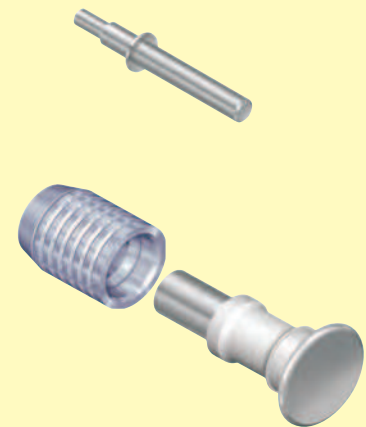
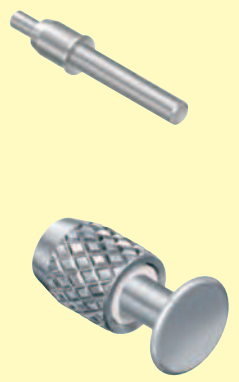
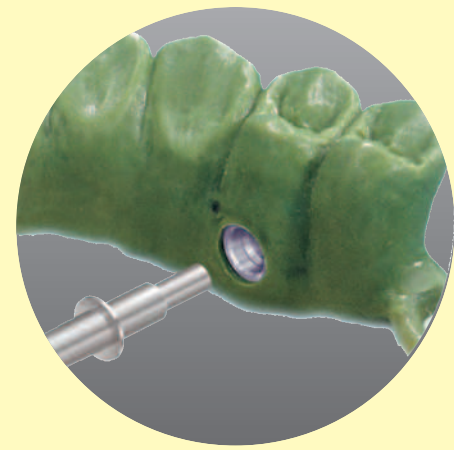
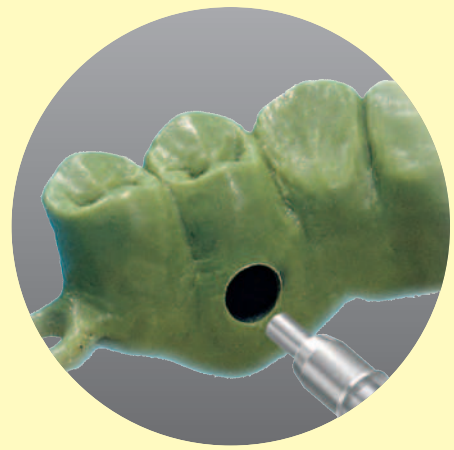



Locking Pin Snap E

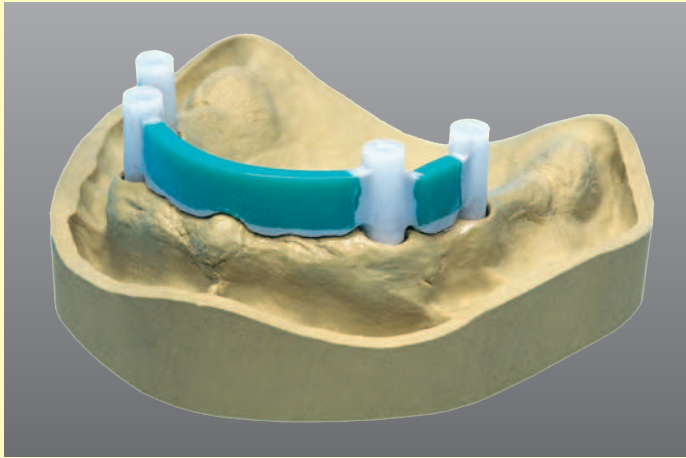

Integration of Locking Pin snap in any alloy.

The wax bars by bredent are fitted in individually.

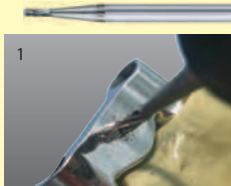

1 The position of the locking pin is determined with the centre drill and a small depression is prepared.



2 The Diatit-Multridril is safely positioned by centering.



3 Thanks to little space required by the Locking Pin snap, the hole can be easily positioned in the patrx element.

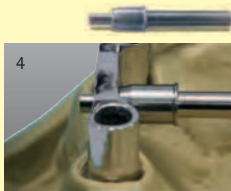

4 The modelling pin E is inserted in the patrx hole up to the stop.



5 The modelling pin E is integrated in the pattern using Pi-Ku-Plast resin and modelling wax.



6 After completion of the pattern, the modelling pin E is removed by turning it slightly with a pair of pliers.



7 The investment compound in the Locking Pin housing is sandblasted with a grain size of 110 µ and a pressure of 4 bar.



8 Insulating and glueing in are carried out as described on page 43.

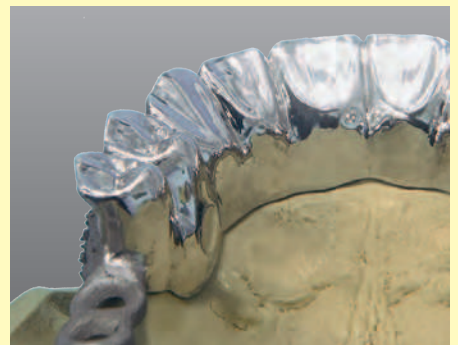

Assortment

4 pieces
Locking Pin Snap E
2 Locking Pin Snap E
2 Modelling pin E
REF 440 0065 2

Locking Pin Snap A

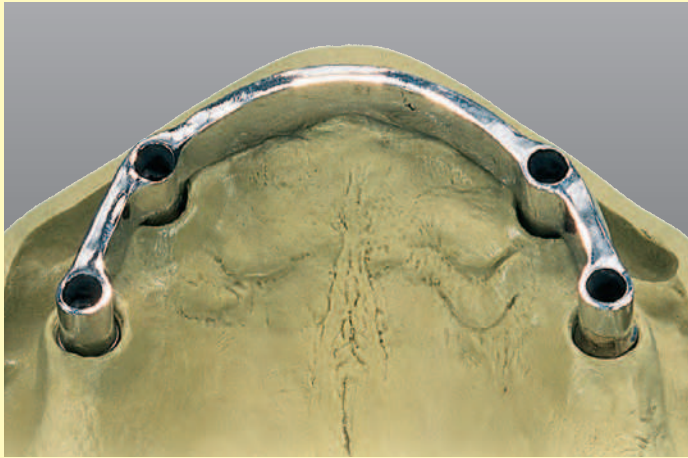

Time-saving casting-on to precious metal secondary constructions.

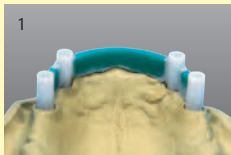

The wax bars by bredent are fitted in individually.

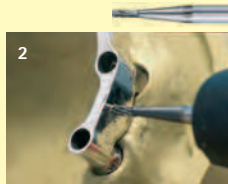

The position of the locking pin is determined with the centre drill and a small depression is prepared.



The bar is perforated with the Diatit-Multi-drill whilst adding rich quantities of milling and drilling oil.



Thanks to the little space required by the locking pin snap, the hole can be easily positioned in the patrix element.



The cast-on locking pin sleeve is put onto the modelling pin A and inserted into the locking pin hole of the patrix up to the stop.

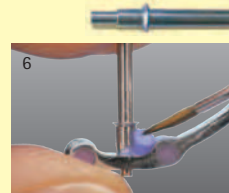

The modelling pin A with the cast-on locking pin sleeve is integrated in the pattern up to its largest diameter using Pi-Ku-Plast resin and modelling wax.



After waxing up, the modelling pin A is removed with a slight turn.

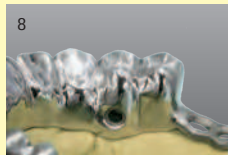

In order not to damage the cast-on locking pin sleeve, the investment compound is removed with glass beads.

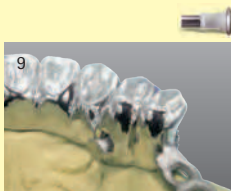
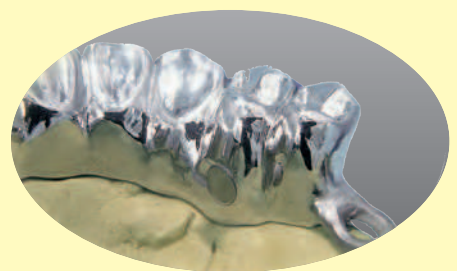

The Locking Pin Snap is pressed in the locking pin sleeve that has been cast in.

Assortment

- 4 pieces
- Locking Pin Snap A**
- 2 Locking Pin Snap A
- 2 Modelling pin A
- REF 440 0065 4



Locking Pin Snap System

Accessories



Ceramic spacer E
2 pieces
REF 440 0065 7



Device for waxing-on
1 piece
REF 440 0066 1



Locking Pin Snap
1 piece
REF 440 0065 9

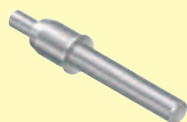

Modelling pin E
1 piece
REF 440 0065 6

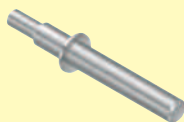

Modelling pin A
1 piece
REF 440 0065 5



Tungsten carbide center drill
REF 330 0066 0



Diatit-Multidrill
REF 330 0073 0



Rapid Microbur
REF H001 NH 21



Milling and drilling oil
20 ml
REF 550 0000 8



Wax bars wstg
1,6 x 8,0 mm
REF 430 0265 0



FGP insulating liquid
REF 540 0102 7



Assortment - DTK-adhesive
1 x 8 g double-mix cartridge
DTK-adhesive
10 x mixing cannula
1 x syringe piston
1 x disposable brush holder
10 x disposable brush
REF 540 0118 5



Pi-Ku-Plast HP 36 resin
red
REF 540 0022 0
blue
REF 540 0021 9

Locking Pin activatable



Universal active. The pin can be located on either the oral or buccal surfaces.



Locking pin: Resistant to the oral environment. Made of special steel, with spark eroded activating slot and wax spacer.



The metal matrix pre-former ensures that the pin guidance is absolutely parallel.



Locking pin matrix: This prefabricated wax matrix reduces the time required when waxing-up chrome cobalt appliances.

Locking pin matrix with concave surface for waxing onto the pattern.



„Mini“ locking pin: The smallest in the bredent Locking Pin System.



The „Mini“ locking pin matrix, simplifies fitting of the locking pin.

„Mini“ locking pin matrix: Saves space, ideal for anterior use.



The pin viewed from the lingual direction. The pin passes through an extra-coral retaining lug.



This pin can be operated from the buccal aspect.



The spark eroded activating slot is simply activated from the underside.



Locking Pin activatable

Locking Pin System

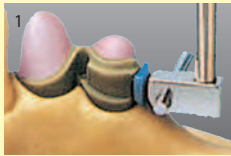

1 Wax-up the pattern using standard methods, and then use the paralleling mandrel to wax the matrix into place.

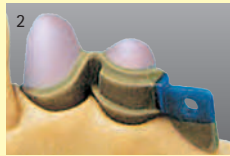

2 Adapt the underside of the matrix to fit the model and integrate it into the shear distributor.



3 Trim and polish the framework before applying the porcelain.



4 Place the matrix pre-former in position and secure it with the oxidized steel pin. Block out the underside.



5 Remove the matrix pre-former and fill the pin aperture with wax, leaving a slight depression.



6 Position the wax matrix correctly on the investment model.



7 Wax-up the denture base framework using standard methods.



8 Shows the chrome cobalt framework after casting and trimming. The apertures for the pin have been aligned accurately.



9 Shows the try-in, with temporary pin made of clasp wire.

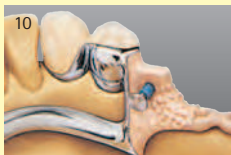

10 Insert the pin until the wax sleeve touches the chrome cobalt framework.



11 Shows the completed saddle: The locking pin is pulled to open it.



12 Viewed from the underside. The slot in the pin enables it to be activated easily.

Assortment

Pack of 2 sets

Locking pin system*

- 1 blocking out matrix
- 2 locking pin matrices
- 2 locking pin patrices
- 1 steel pin 1.5 mm
- 2 locking pins, activatable

REF 430 0445 0

Assortment

Pack of 2 sets

Locking pin system mini*

- 1 blocking out matrix
- 2 locking pin matrices
- 2 locking pin patrices
- 1 steel pin 1.5 mm
- 2 locking pins, activatable

REF 430 0460 0

Accessories



Locking pin matrix
4 pieces REF 430 0458 0



"mini" locking pin matrix
4 pieces REF 430 0490 0



Locking pin patrix
4 pieces REF 430 0458 0



"mini" locking pin patrix
4 pieces REF 430 0490 0

Locking Pin bs1 Overview of products

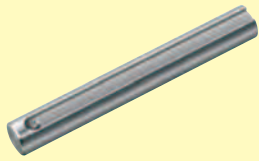

Pin axles
2 pieces REF 450 0006 4



Bolt screws
2 pieces REF 450 0006 5

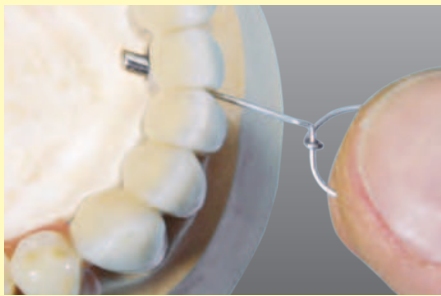

The lock axles can be shortened according to the respective situation and an individual unlocking lens can be added.

The locking pin bs 1 is perfectly suitable for the use in the anterior area. The lock can be opened using a bent wire and then the denture can be removed.



The locking pin bs 1 can be used individually.
Thanks to its size the locking pin bs 1 is perfectly suitable for unilateral removable dentures. An undercut can be integrated into the pin axle to open it.



The completely individual solution:
The unlocking lens is prepared individually using denture resin or composite. This way the unlocking device is no longer visible.



Locking Pin bs1

Type 1: Bolt screw in metal framework

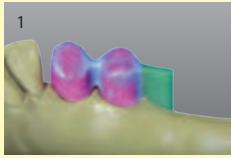

Wax up the pattern using standard methods. The prefabricated wax bar (REF 430 0265 0) is perfectly suitable to allow quick fabrication.

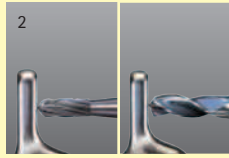

Prepare a small depression with the center drill and drill a hole through the bar using the Diatit-Multidrill spiral drill.

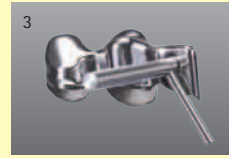

Assemble the auxiliary modelling elements 2.0 and 1.3 and position them in the drill hole so that between primary element and auxiliary element 1.3 ...



... a minimum space of 1.5 mm is obtained. Fix the auxiliary modelling elements with Pi-Ku-Plast.



Complete the model in accordance with the situation. Remove the auxiliary modelling elements, invest and then cast.



After casting, cut the thread with the taps whilst adding a rich quantity of milling and drilling oil.



Cut the lock axle according to the respective situation. Add an unlocking device and fix the pin axle with the bolt screw.

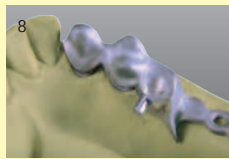

The individually fabricated locking pin can also be used if only limited space is available.

Type 2: Bolt screw in resin saddle



Insert the auxiliary modelling element 2.0 x 3.5 in the center of the drill hole as spacer for the investment model. Prepare the model for duplicating.

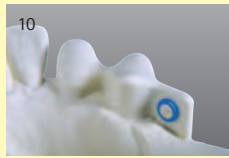

Place the wax sleeves on the investment model to obtain an accurate, uniform wall thickness of the model.



Complete the model (waxing up). The plugs of the auxiliary modelling element remain visible.

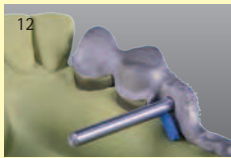

Fix the wax screw in the auxiliary modelling element 2.0 and fit it in the drill hole. There must be a distance of 1 mm between the wax screw and the secondary construction.



After completion the wax screw is removed with steam. Precise has been achieved in the resin which safely accepts the bolt screw. The pin axle is cut individually and an unlocking device is added. If required, the lock axle can be veneered in a suitable shade. A reliable, simple solution for any type of removable dentures.



Assortment

17 pieces

Locking Pin bs 1

REF 450 0006 2

Locking Pin bs1

Accessories



Wax screws
2 pieces
REF 430 0748 2



Auxiliary modelling elements 2.0 x 3.5
2 pieces
REF 450 0007 0



Auxiliary modelling element 2.0
2 pieces
REF 450 0006 3



Wax sleeves 2.0/1
2 pieces
REF 450 0007 2



Auxiliary modelling elements 1.3
2 pieces
REF 450 0007 1



Tap handwheel
1 piece
REF 330 0115 3



First tap M 1.6
1 piece
REF 330 0116 V



Last tap M 1.6
1 piece
REF 330 0116 F



Milling and drilling oil
20 ml
REF 550 0000 8



Tungsten carbide center drill Ø 1.4
1 piece
REF 330 0066 0



Diatit-Multidrill spiral drill 2.0
1 piece
REF 330 0072 0



Swivel-type lock sr Overview of products



**Latch retainer with in-
tegral shear distributor**

left, 4 pieces
REF 430 0735 8

right, 4 pieces
REF 430 0735 9

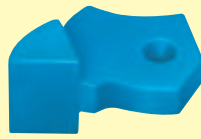

Latch tongue

4 pieces REF 430 0735 7

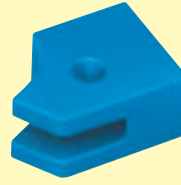

Latch box

4 pieces REF 430 0735 6

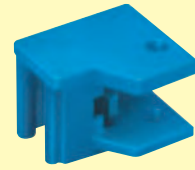

**Shear distributor
housing**

left, 4 pieces
REF 430 0730 9

right, 4 pieces
REF 430 0731 0

Swivel-type lock src Overview of products



**Latch retainer with in-
tegral shear distributor**

left, 4 pieces
REF 430 0735 8

right, 4 pieces
REF 430 0735 9

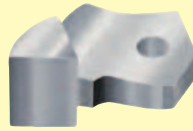

Latch tongue titanium

2 pieces REF 430 T735 7



**Latch blades src
ceramic**

2 pieces REF 430 0738 5

Swivel-type lock sr



Ceramic spacer for simple fabrication of locks in the one-piece casting technique.
Swivel-type locks for CoCr restorations: low-cost, accurate and time-saving.

Cross-section through the Latch System sr

locked

unlocked

Fully assembled Latch System sr





Swivel-type lock sr

This cost-effective latch allows you to calculate your prices to optimize your profit.

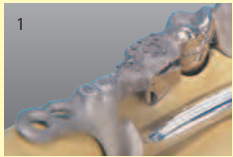

Classic shear distributor with Interlock and a complete latch system. The chrome cobalt framework and latch system were luted with dtk without creating stresses.



Latch box with individually modelled latch box housing. Ideal when minimal space is available.

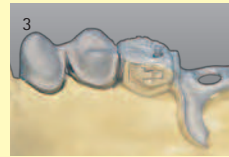

Construction of a monoreducer with integrated shear distributor. The usage of the latch box housing avoids modelling of the shear distributor.

Applications for combined fixed/re-movable appliances with classic shear distribution arms.

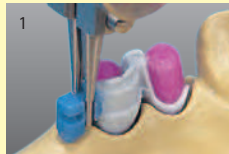

The latch retainer can be fitted onto the papillae accurately.

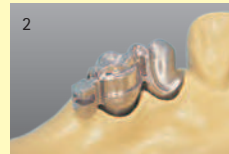

The non-soldered, one-piece casting reduces the costs and the number of alloys used in the mouth.

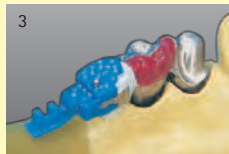

The shear distribution arm pattern is built up with Pi-Ku-Plast brush-on resin to guarantee that all details are reproduced.



The latch system provides numerous combinations for fabricating custom restorations.

Applications for combined fixed/re-movable appliances with a space-saving latch retainer.

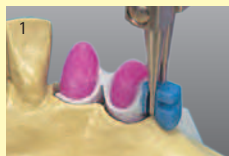

As the latch retainer is designed to fit around the papillae, it can be waxed close to the crown with a paralleling mandrel.



The shear distributor shoulder on the matrix eliminates the need for labour intensive milling, which saves time and money.



The slender design of the latch system allows the shear distributor housing to be waxed up as required.



The restoration is designed so as not to stress the abutment teeth.

„Monoreducer“ with integral shear distributor and custom designed latch box housing.

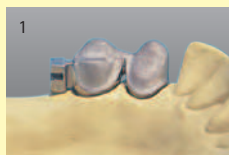

Matrix with integral milled shoulder for the shear distributor - saves time and space.

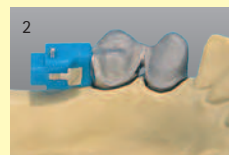

The latch tongue swivels horizontally into the latch retainer.



The latch system is very easily assembled.



Once the latch has been opened, the partial denture can be released without stressing the abutment tooth.

Assortment

14 pieces
Swivel-type lock sr left + right
REF 430 0736 2

Assortment

14 pieces
Swivel-type lock sr left
REF 430 0730 5

Assortment

14 pieces
Swivel-type lock sr right
REF 430 0730 6

Swivel-type lock src



Ceramic spacer for the simple fabrication of locks in the one-piece casting technique.

Swivel-type locks for CoCr restorations: low-cost, accurate and time-saving.



Wax latch retainer

- is cast together with the anchor crowns, hence reduction of metals in the mouth
- integrated shear distributor provides enhanced esthetics and simplifies the fabrication



Ceramic latch blade with lock axle

- Latch box premodelled in wax, hence quick fabrication is possible
- is integrated into the CoCr model
- only sandblasting required after casting
- creates precise fitting surfaces for metal, latch blade and latch axle



Titanium latch blade

- shape matched exactly with the ceramic lock blade prefabricated precision lock blade
 - ensures efficient processing
- Latch axle**
- stainless-steel, hence orally stable
 - matches exactly with the ceramic spacer for the latch axle, simplifies the integration

High-precision ceramic patterns are available which reduce the amount of work tremendously and simplify the fabrication of an individual lock. The ceramic pattern designs are based on the design of the latch blade and the latch axle so that they fit exactly into each other. The latch box is cast in one piece together with the CoCr structure using the one-piece casting technique. Soldering is not required. Accordingly, the amount of alloys used intraorally is reduced and the costs for individual lock restorations are lowered.



Swivel-type lock src

Ceramic spacer for the simple fabrication of a latch retainer.



1 The latch retainer is waxed with the paralleling mandrel to the primary construction according to the path of insertion. When producing a bar restoration, the integrated shear distributor may be covered with wax.



2 After casting, prepare the model for duplicating. Block out the lock of the latch retainer so that approx. 0.5 mm of the margin remains visible after duplicating.



3 The latch retainer can be easily seen on the investment model. The ceramic pattern can be safely positioned in the lock.

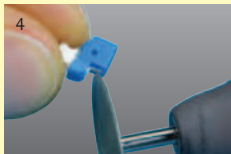

4 Trim the ceramic pattern with a separating disc in a way that it fits precisely into the lock of the latch retainer and ...

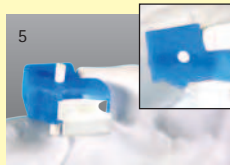

5 ... ends exactly at the latch retainer but can still be positioned safely in the lock of the latch retainer.



6 Fix the ceramic pattern with the axle and attach with wax.



7 Complete the model in accordance with the situation and integrate the ceramic pattern. The axle should stand out on both sides of the model.

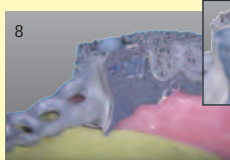

8 The titanium swivel-type lock is fitted into the sandblasted housing. Put the latch spring behind the titanium swivel-type lock and fix with the axle.

Assortment

10 pieces

Latch tongue src left + right

REF 430 0738 8

Accessories Swivel-type lock sr/src



Oxide-steel pins

20 pieces

REF 430 0293 0



Latch spring

10 pieces

REF 430 0334 0



Paralleling mandrel universal

1 piece

REF 360 0115 1



Ceramic pins

2 pieces

REF 430 0738 6



Activatable frictions cylinder Overview of products



Friction cylinders

2 pieces each
REF 440 0068 0



Titanium screws

Stud fixator Overview of products



Fig. 1:1

2 pieces REF 440 0265 1

Friction fit system FGP Overview of products



Assortment REF 540 0102 8



Activatable frictions cylinder

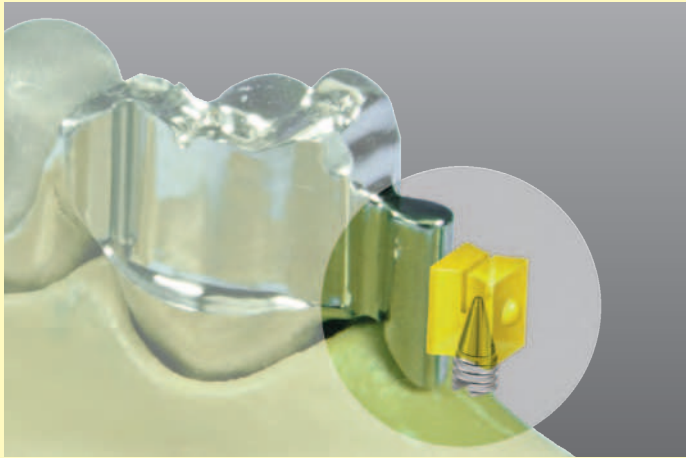

Individually adjustable, biocompatible plastic cylinder with titanium screw. Easy integration and safe hold of the denture due to the special shape of the friction cylinder.

- individually adjustable friction
- safe hold in the CoCr structure due to the retention stud



1 Activatable use of the friction cylinder is possible with the attachment of the VS 3 group or with telescopic crowns.



2 Always use a shear distributor for attachments.



3 The plane surface of the friction cylinder is attached to the matrix.



4 Prior to duplicating, blocking out with wax to the basal direction is carried out and the model is prepared in the usual way.



5 The precise reproduction of the friction cylinder ensures accurate fit in the CoCr structure.



6 Prepare the model for investing in the usual way.



7 The friction cylinder is pressed into the CoCr structure using a blunt object. The screw seat is facing the basal area.



8 Due to the adjustment of the titanium screw, the hold of the denture can be individually adjusted to the respective patient.



Perfectly suitable for telescopic crowns



Assortment

4 pieces
2 Friction cylinders
2 Titanium screws
REF 440 0068 0



Assortment

20 pieces
10 Friction cylinders
10 Titanium screws
REF 440 0068 1



Stud fixator



As a snap element or to increase the friction for new restorations and repairs.

Ceramic stud and cavity-filling silicone as buffers ensure durability and soft integration of the restoration.

- Time is saved thanks to quick and easy integration
- Friction is restored subsequently
- Ceramic stud for prolonged comfort of wearing
- Hygiene-friendly thanks to cavity-filling silicone

Procedure in the laboratory

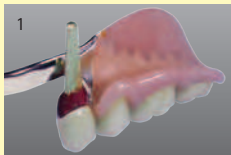

To reproduce the oral situation accurately, use Pi-Ku-Plast to fabricate the primary construction



and to produce a working model.



Prepare a matrix before removing the resin saddle.



Drill a hole with a diameter of 2.1 mm into the secondary element and place it back on the model.



Use the drill (Ø 2.1 mm) to carefully prepare a groove with a max. depth of 0.4 mm in the resin saddle.



The stud fixator is fitted in the CoCr structure and fixed with DTK adhesive.



The housing of the stud fixator must be flush with the crown wall. Only the ceramic stud may stand out in the crown. Reattach the resin saddles.

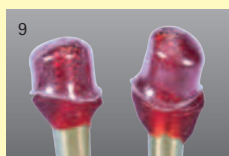

Prepare a coping of the resin die using a thermoforming foil.



Mark the groove on the resin die with a pen. Drill a hole (Ø 2.1 mm) through the die coping at this point.

Procedure in the practice



Place the die coping onto the primary construction in the mouth and transfer the position of the groove accurately.



Integrate the restoration with friction being restored.

Accessories



Assortment – DTK-adhesive
 1 x 8 g double-mix cartridge
 DTK-adhesive
 10 x mixing cannula
 1 x syringe piston
 1 x disposable brush holder
 10 x disposable brush
 REF 540 0118 5



Rapidly Microbur
 REF H001 NH 21



Pi-Ku-Plast HP 36 resin
red
 REF 540 0022 0
blue
 REF 540 0021 9



Friction fit system FGP

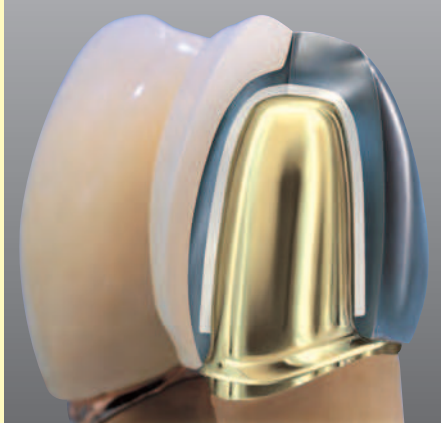

Individual friction for highest demands.

The friction fit system offers the dentist and the dental technician an entirely new perspective during the preparation and the restoration of the friction for all types of telescopic metal restorations. Long service life and simple, time-saving processing render the friction fit system a comfortable solution for your patients.

Application fields of the FGP system

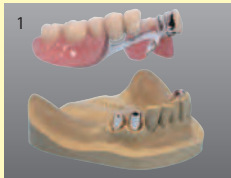

Safety and outstanding quality

The FGP system by bredent offers optimum and individual friction when preparing new conical and telescopic restorations.



Direct solution instead of extended waiting times

Due to the use of FGP directly in the dental practice. The simple use during the restoration of the friction of telescopic work is the solution for the dentist and the patient.

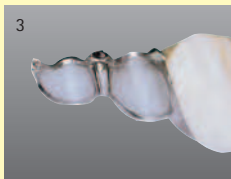

Individuality and precision

These requirements can still be fulfilled even in areas difficult to access, whether new dental supply or relining work are concerned.



No compromises

During the preparation of new individual attachments. The FGP system allows to obtain results that fulfill highest demands.

25 years of experience with the FGP

Discover the personal advantages:

- ➔ Saving of time due to fast and simple preparation
- ➔ Preparation of individual friction at favourable costs
- ➔ No fitting of secondary elements
- ➔ Long service life
- ➔ Maximum comfort of wear for the patients
- ➔ Allows low-cost single-piece casting
- ➔ Can be processed in the mouth
- ➔ Almost without any wear
- ➔ Low susceptibility to plaque thanks to highly compacted resin surface

Up until today these advantages have contributed in more than 50,000 cases to achieving soft integration and removal of the denture.

The principle of the FGP resin is based on the fact that the metal fit that has been common in the telescopic technique so far will now be replaced by a metal-resin fit.

The metal-resin fit offers the benefit of a considerably more favourable coefficient of friction than the one of a pure metal fit. Consequently, increased resistance to wear and extended service life are obtained.



Friction fit system FGP

New fabrication of telescopic crowns

	<p>Thermo-forming or immersion wax copings serve as spacer for the FGP resin.</p>		<p>with a wall thickness of at least 0.2 mm ending 1 mm above the cervical margin.</p>		<p>The investment material model with cervical step is prepared before</p>
	<p>the usual outer telescopic and cast pattern.</p>		<p>After casting - made with any alloy -</p>		<p>the cast frame is finished and veneered with resin or ceramic materials.</p>
	<p>Due to the preparation during the modelling a gap resulted which is now filled with FGP.</p>		<p>In a preparatory step the pattern is insulated.</p>		<p>FGP bonding agent is applied equally thinly onto the inner surfaces.</p>
	<p>The material is hardened at air for 5 minutes; during this time a visible layer is obtained.</p>		<p>The FGP two-component resin is mixed in the ratio of 1 : 1</p>		<p>and filled into the outer telescopes without any bubbles.</p>
	<p>The restoration is placed onto the model exerting uniform pressure.</p>		<p>The hardened FGP resin with a clearly visible border at the cervical margin.</p>		<p>The FGP system offers individual friction with maximum comfort of wear.</p>

The enhanced friction

Tests and scanning electron microscope studies with FGP reveal clearly better values of friction than those of metal fits.

For this comparison between a classical metal fit and a FGP fit 21,000 integration and removal processes were simulated. This corresponds to a period of wear of approx. 20 years.



Conventional metal/metal fit.
Metal fit after completion adjusted to a frictional force of 8 Newton.



FGP resin/metal fit.
Resin fit after completion adjusted to a frictional force of 8 Newton.



Scanning electron microscope picture of the inner side of a telescopic secondary element made of a precious metal alloys with a magnification x 100.

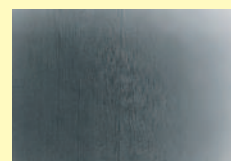

Scanning electron microscope picture of the inner side of a telescopic secondary element made of FGP resin with a magnification x 100.

Result: Residual friction 2 Newton, that is only 25 %.

Result: Residual friction 6 Newton, that is still 75 %.



Friction fit system FGP

Restoration in case of loss of friction

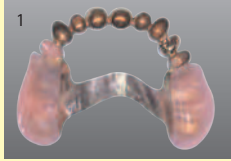

Telescopic work after numerous years of wearing.



During the integration there is no sufficient friction.



Primary telescopes in situ prior to friction relining.



The dial caliper is used to measure the thickness of the outer telescopes.



The outer parts are ground to obtain space for the FGP resin.

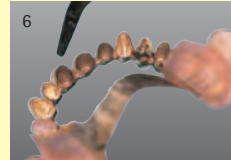

Any residual grinding particles are removed with compressed air.



Retraction threads are put around the primary elements.



Then the inner telescopes are insulated with a small amount of liquid vaseline.



FGP bonding agent is applied equally thinly onto the inner surface of the outer parts.



The FGP two-component resin is mixed in the ratio of 1 : 1

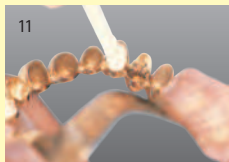

and filled into the outer telescopes without any bubbles.



After the denture has been integrated, the patient is able to bite evenly exerting normal masticatory pressure.



The resin residues must be removed with the probe. Approx. 120 seconds after beginning of mixing, remove the restoration from the primary elements and place it on again.

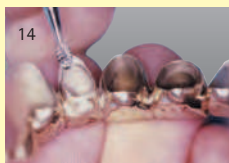

The denture is removed after approx. 7 minutes and excess material is removed with a rotating tool.



The result is a functional denture that exhibits excellent comfort of wear within a very short period.

FGP in implantology

Absolutely tension-free fit.



The excellent sliding properties of FGP resin ensure gentle, implant-protecting integration and removal of the supra-constructions.

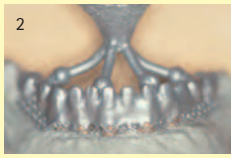

Even very small tensions in the low-cost and biocompatible single-piece casting process are perfectly compensated.

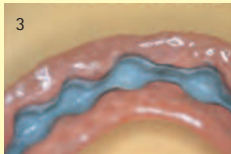

The high resistance to abrasion and non-tilting integrating and removing of the supraconstruction provide patients with a high comfort of wear and simple handling of their dentures.



The friction with FGP resin that will remain stable over many years guarantees the patients' happiness and satisfaction.

Assortment

Friction fit system FGP

REF 540 0102 8

- 1 x 2.5 g Friction resin component A
- 1 x 2.5 g Friction resin component B
- 1 x 1.25 ml FGP bonding agent
- 1 x 3.0 ml FGP insulating agent
- 1 Spatula
- 5 Brushes
- 1 Brush holder
- 1 Mixing block
- 10 Application cannulas





Friction fit system FGP

Accessories



Friction resin component A
REF 540 0108 A



Friction resin component B
REF 540 0108 B



FGP bonding agent
REF 540 0102 6



FGP insulating agent
REF 540 0102 7



Mixing block
35 x 50 x 10 mm
10 pieces
REF 330 0114 4



Disposable brushes
100 pieces
REF 330 0114 2



Spatula
100 pieces
REF 330 0114 3



Brush holder, bent
12 pieces
REF 330 0114 1



Application cannulas
25 pieces
REF 580 0001 8



Cylindrical attachment zg Overview of products

Matrix housing

For the integration in resin



Titanium matrix housing K

2 pieces REF 440 0230 2
8 pieces REF 440 0230 8

For the integration in metal

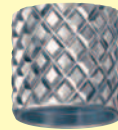

Titanium matrix housing M

REF 440 0240 2
REF 440 0240 8

Matrices

Friction

Friction and snap matrices can be exchanged among each other.



green – reduced friction
4N

8 pieces REF 440 0150 8



yellow – normal friction
6N

REF 440 0140 8



red – high friction
8N

REF 440 0130 8

Snap



green – reduced friction
4N

8 pieces REF 440 0180 8



yellow – normal friction
6N

REF 440 0170 8



red – high friction
8N

REF 440 0160 8

Accessories



Paralleling mandrel universal 2

1 piece
REF 360 0116 0



Insertion pin

1 piece
REF 360 0116 4



Matrix pliers

1 piece
REF 310 0000 6



Assortment – DTK-adhesive

1 x 8 g double-mix cartridge
DTK-adhesive
10 x mixing cannula
1 x syringe piston
1 x disposable brush holder
10 x disposable brush
REF 540 0118 5



Impression transfer set

Transfer patrix
2 pieces
Transfer matrix
2 pieces
REF 440 0116 3



Transverse fixation

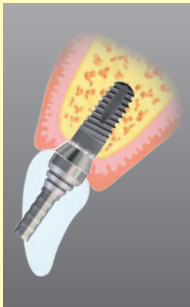

In angled implants, diagonal screwing often means that the screw channel is on the surface of the crown, which also cannot always be compensated for using appropriate angled abutments. Aesthetic problems can therefore occur. In the area of the lateral teeth, the opening of the screw channel can lead to problems with diagonal load distribution.



The solution for this is transverse fixation. The bredent group offers various systems for this:

- Assembled transverse screwing to the SKY system
- Individual transverse fixation, suitable for all implant systems

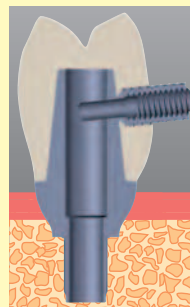

Security-Lock – the screw sits in the secondary part and the prosthetic restoration is bolted in the abutment



Friction Splint – fixation of the prosthetic restoration without a threaded hole

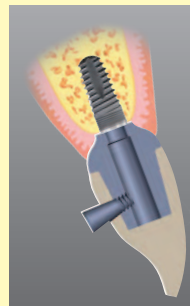

Individual screwing – conical titanium screw with the corresponding toolkit

Clinical case

Final restoration with milled NPM framework and veneered with the visio.lign system. 4 implants screwed transversally and 2 implants screwed occlusally. (Stefan Adler, Dental Technician, Landsberg)





Assembled transverse fixation

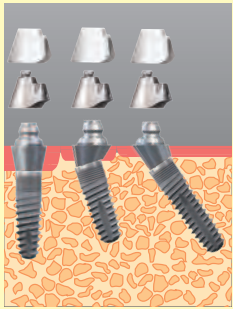

For the straight and angled abutments of the SKY fast & fixed system, large and small bridges can be manufactured to a high aesthetic level with prosthetic caps for transverse screwing, as no screw channels impede the aesthetics. All framework materials can be used with this type of screwing - titanium, gold, NPM, ceramic, BioHPP. The "passive fit" of the bridge construction is ensured by oral bonding.

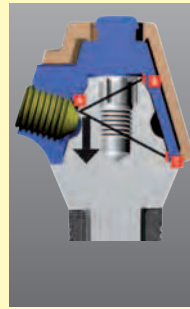

A highly secure and sealed connection is created using three-point fixation and the contact pressure generated by tight screwing of the prosthetic caps into the abutment platform.

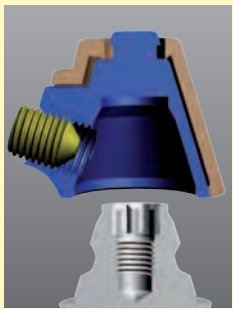

The simplicity of use, particularly in the patient's mouth is ensured thanks to the variability of the screw position (360° in the case of straight abutments and 270° in the case of angled abutments), as access to the screw can always be positioned in an optimum manner. Moreover, the screw remains in the bridge so that protracted and difficult threading in the mouth is avoided. Transverse fixation can also be combined simply with diagonal screwing.

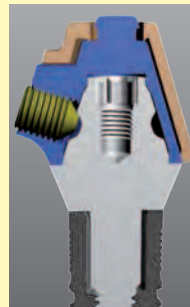

**SKY fast & fixed
Abutment 0°**
with integrated screw
Height 1 mm
REF SKYFT001
Height 2 mm
REF SKYFT002
Height 4 mm
REF SKYFT004



**SKY fast & fixed
Abutment 17,5°**
with screw 2,2
Height 3 mm
REF SKYFT173
Height 5 mm
REF SKYFT175



**SKY fast & fixed
Prosthetic coping**
Transversal screw-
retained
REF SKYFTPKS



**SKY fast & fixed
Abutment 35°**
with screw 2,2
Height 4 mm
REF SKYFT354
Height 5 mm
REF SKYFT355



Security-Lock Overview of products

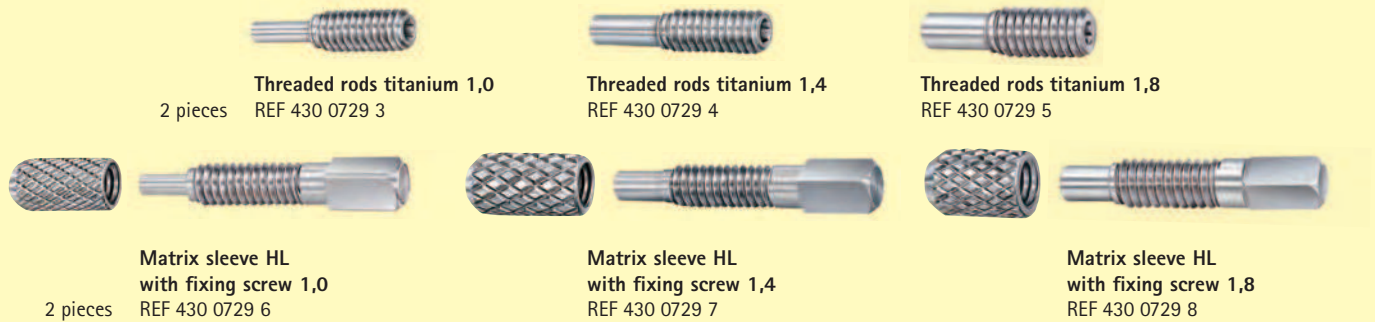

Security-Lock-Ceramic Overview of products

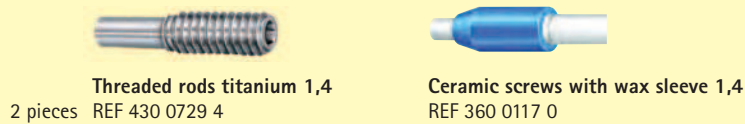

Security-Lock-adhesive sleeve Overview of products

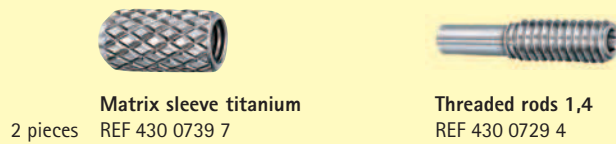

Friction Splint FS1 Overview of products





Security-Lock

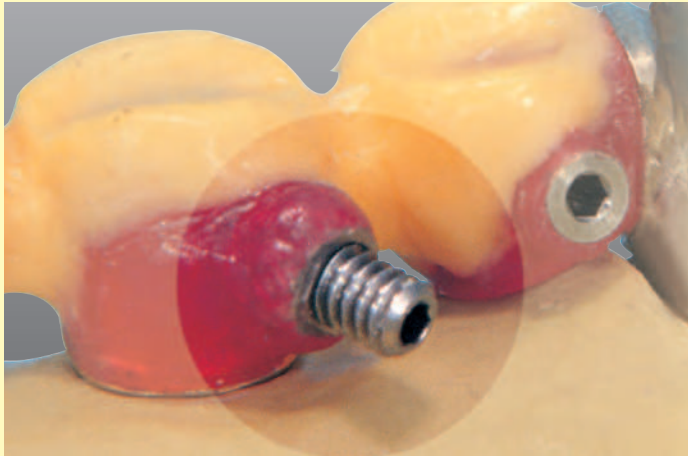

Patented threaded units which do not loosen or break. As the non-threaded section is in the inner coping, no micro-movements can be transferred. This guarantees that the threaded rod will not loosen inadvertently.

The matrix sleeve made of a high-melting cast-on alloy can be cast on up to max. 1300 °C.

The threaded rods are available in three different sizes (1.0/1.4 and 1.8 mm) and suitable for any situation.



1 The different sizes can be used for a wide range of applications with implants and bridges etc.



2 In this case, a superstructure is to be retained with a screw. The abutment should be waxed up using standard procedures.



3 Once the abutment has been cast, it should be milled and polished.



4 A centring drill is used to create a purchase point in the correct position.



5 The correct size of Multidrill is used to drill a hole at the correct angle for the threaded rod. It is absolutely essential that brent milling/drilling oil is used.



6 Screw the threaded rod into the threaded sleeve. Both the pin and hexagonal socket (max. reduction: 2.3 mm) can be reduced as required.

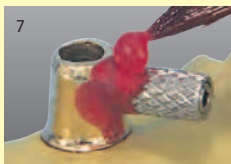

7 Coat the threaded rod and sleeve with Pi-Ku-Plast, REF 540 0021 9.



8 Pi-Ku-Plast guarantees optimum strength for continued processing.

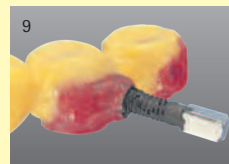

9 Screw a retention screw coated with colloidal graphite into the threaded sleeve to retain it in the investment material, REF 540 0070 6.

Assortment

9 pieces
Security-Lock 1.0
2 Threaded rods
2 Matrix sleeves

2 Fixing screws
1 Diatit-Multidrill
1 HM-Centring drill
1 Screwdriver short
REF 430 0729 0

Assortment

9 pieces
Security-Lock 1.4
2 Threaded rods
2 Matrix sleeves

2 Fixing screws
1 Diatit-Multidrill
1 HM-Centring drill
1 Screwdriver short
REF 430 0729 1

Assortment

9 pieces
Security-Lock 1.8
2 Threaded rods
2 Matrix sleeves

2 Fixing screws
1 Diatit-Multidrill
1 HM-Centring drill
1 Screwdriver short
REF 430 0729 2



Security-Lock-Ceramic



Security-Lock-Ceramic 1.4 allows splinting for all alloys without a thread sleeve.

Restorations made of a CoCr alloy which are to be veneered are biocompatible and can be produced without any additional alloy components.

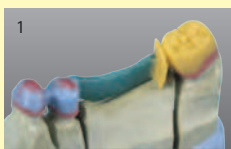

The wax model of the primary constructions is prepared in the usual way.



Any alloy can be used for casting, even CoCr alloys.



After parallel milling, the secondary element is moulded using Pi-Ku-Plast.



To determine the exact position of the screw, the wax-up is modelled according to the situation.



The wax is removed at the specific point to determine the exact drilling position.

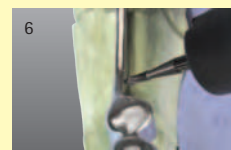

A groove is prepared at this point using the tungsten carbide centering drill.

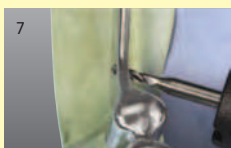

The Diatit-Multidrill 1.4 and milling and drilling oil are used to prepare a hole in the desired direction of screwing.



The auxiliary modelling element is attached to the model using Pi-Ku-Plast and reduced with wax according to the situation.



The wax-up is reduced for ceramic veneering according to the situation.



Using tweezers, the auxiliary modelling element is turned slightly and removed.



After attaching the sprues, the ceramic spacer with wax sleeve is inserted into the opening up to the stop.



The wax sleeve and the model are connected.



The ceramic spacer remains in the metal structure until the ceramic veneer is completed.



The ceramic spacer is removed with the ceramic removing tool - do not remove with the sandblaster.

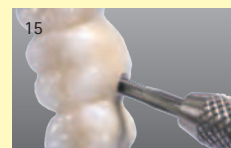

The thread is recut using the first and the second tap. Use milling and drilling oil when tapping.



The threaded rod is turned in and primary and secondary element are screwed with each other.



The threaded rod is shortened to the required length (max. reduction: 2.3 mm) using the Tita-Pol prepolishing wheel.



Security-Lock-Ceramic 1.4 can be processed safely and quickly with just a single alloy. There are no temperature-related alloy problems since finished parts are cast in.

Assortment

10 pieces, 1 piece each
 Auxiliary modelling element
 Ceramic screw with wax sleeve
 HM-Centring drill
 Diatit-Multidrill

Threaded rod 1.4
 First tap, tungsten carbide
 Second tap, tungsten carbide
 Ceramic removing tool
 Tap handwheel
 Screwdriver, short
 REF 430 0739 1



Security-Lock-adhesive sleeve



Security-Lock system is perfectly suitable for situations difficult to access such as small jaws or large-span bridges. The titanium threaded sleeve that can be glued in allows processing independent of the alloy.



1 Any alloy is suitable for casting, even CoCr alloys.

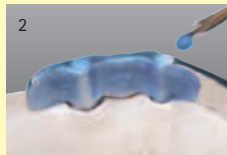

2 After parallel milling and high luster polishing, the secondary element is moulded with Pi-Ku-Plast.



3 To determine the exact position of the screw, the wax up is modelled according to the situation.



4 The wax is removed at the specific point to determine the exact drilling position.

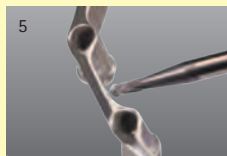

5 A groove is prepared at this point using the tungsten carbide centering drill 1.4.

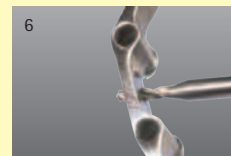

6 The Diatit-Multidrill 1.4 and milling and drill oil are used to prepare a hole in the desired direction of screwing.



7 The auxiliary modelling element is attached to the model using Pi-Ku-Plast and moulded (completed) with wax according to the situation.



8 Prior to investing, the auxiliary modelling element is removed by turning it slightly with a pair of tweezers.



9 Any alloy can be used for casting the secondary construction.



10 All elements that must not be glued – such as the primary construction, the external surfaces of the primary construction and the screw are ...



11 ... separated with FGP insulating liquid (REF 540 0102 7) so that the excessive adhesive can be removed easily.



12 After separating, the threaded rod is turned into the matrix sleeve.



13 Primary and secondary element are assembled. A drop of DTK adhesive is filled and spread evenly in the hole in the secondary element.



14 Matrix sleeve and threaded rod are inserted into the hole and no longer moved until the DTK adhesive has hardened.

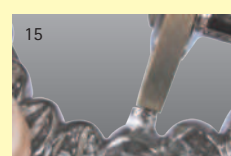

15 The protruding matrix sleeve and the threaded rod are cut off to obtain the required length (max. reduction: 2.3 mm) using the Tita-Pol prepolishing wheel.



16 Ideal for processing high-melting alloys or titanium in very narrow jaws. The Security-Lock-adhesive sleeve ensures simple and quick processing.

Assortment

5 pieces, 1 piece each
Auxiliary modelling element 1.4
HM-Centring drill 1.4

Diatit-Multidrill
Threaded rod 1.4
Matrix sleeve titanium
REF 430 0739 5



Security-Lock

Accessories

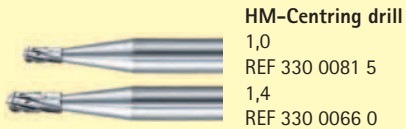

HM-Centring drill
1,0
REF 330 0081 5
1,4
REF 330 0066 0

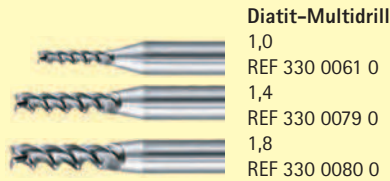

Diatit-Multidrill
1,0
REF 330 0061 0
1,4
REF 330 0079 0
1,8
REF 330 0080 0



Screwdriver short
1 piece
REF 330 0069 0



Milling/drilling oil
REF 550 0000 8

Security-Lock-Ceramic

Accessories



Auxiliary modelling element 1.4
REF 360 0116 9



Diatit-Multidrill
1,4 x 6 mm
REF 330 0079 0



HM-Centring drill 1,4
REF 330 0066 0

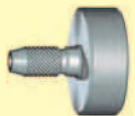

Tap handwheel
REF 330 0115 3



First tap, tungsten carbide
REF 460 0010 M



Second tap, tungsten carbide
REF 460 0010 F



Screwdriver short
1 piece
REF 330 0069 0



Ceramic removing tool
REF 460 0010 6



Milling/drilling oil
REF 550 0000 8

Security-Lock-adhesive sleeve

Accessories



Auxiliary modelling element 1.4
REF 360 0116 9



HM-Centring drill ,4
REF 330 0066 0



Diatit-Multidrill
1,4 x 6 mm
REF 330 0079 0

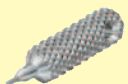

Screwdriver short
1 piece
REF 330 0069 0



Milling/drilling oil
REF 550 0000 8



FGP insulating agent
REF 540 0102 7



Assortment - DTK-adhesive
1 x 8 g double-mix cartridge
DTK-adhesive
10 x mixing cannula
1 x syringe piston
1 x disposable brush holder
10 x disposable brush
REF 540 0118 5



Friction Splint FS1



Connecting elements for superstructures.

- uncomplicated integration in the mouth
- defective screw connectors can be repaired with FS1
- FS1 is replaceable
- time-saving, no tapping necessary
- variable application for all indications
- can be individually shortened
- no loosening through expansion

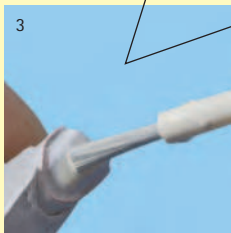
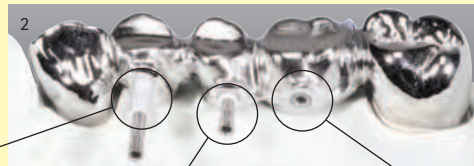

The FS1 sleeve is pushed into the congruent splint hole running through the primary and secondary part with the pre-assembled splint screw.

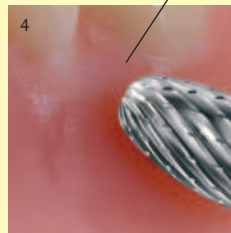

The FS1 sleeve is pushed into the congruent splint hole running through the primary and secondary part with the pre-assembled splint screw.

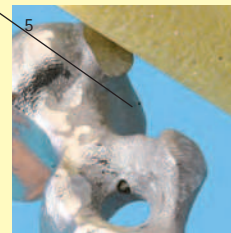

...the splint screw is screwed in.

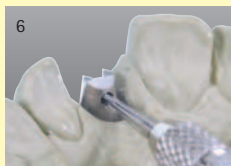

No tapping is necessary.



Damaged screw connectors...



.....can be re-tooled with the FS1.



Friction Splint FS1

	<p>Wax-up with matrix.</p>		<p>Remove the wax-up. The pin hole is drilled into the abutment with the Diatit-Multidril Ø 2,0 mm.</p>		<p>The wax-up is placed back onto the model. The modeling aid is integrated in the wax-up. Holes with a diameter of 2.0 mm are drilled into the full wax-up at the positions for the attachments.</p>
	<p>The attachments are milled. The previously prepared matrix serves for orientation. The ceramic spacer can be used to ensure perfect casting of the splint holes.</p>		<p>Using the modeling aids...</p>		<p>... the secondary units are waxed up and prepared for casting.</p>
	<p>Sleeve...</p>		<p>...and splint screw are shortened to the same length if required.</p>		<p>In the case of zirconium crowns it must be ensured that ...</p>
	<p>...the diameter of the drillhole is 2.0 mm after the sintering process and ...</p>		<p>...the ceramic firings. Stress/tension within the ceramic can only be avoided in this way.</p>		<p>The splint screw which is screwed half way into the sleeve is positioned using tweezers...</p>
	<p>...and pressed in. The remaining section of the splint screw is turned in.</p>		<p>The splint can be removed by turning it out with the screwdriver SW 0,9.</p>		<p>The screwed-in fixing screw is removed from the sleeve.</p>
	<p>In case of usage of less than 1 year and in undamaged condition, the removed sleeve can be reinserted.</p>				

Accessories

	<p>Modeling aid Ø 2.0 mm 2 pieces REF 450 0008 3 10 pieces REF 450 0008 7</p>		<p>Spacer Ø 2.0 mm 2 pieces REF 450 0008 2 10 pieces REF 450 0008 6</p>		<p>Diatit-Multidril 2,0 1 piece REF 330 0072 0</p>
	<p>Fixing screw 2 pieces REF 360 0103 0</p>		<p>Screwdriver short 1 pieces REF 330 0069 0</p>		<p>Milling/drilling oil REF 550 0000 8</p>



Screw connections

Bridge-sectioning Attachment oc / custom Overview of products



Fig. 1:1
Titanium screw
1 piece REF 330 0070 0
10 pieces REF 330 0071 0



Fig. 1:1
Closing ring HL, cast-on
2 pieces REF 430 0730 4



Bridge-sectioning studs oc
2 pieces REF 430 0730 3



Custom bridge-sectioning attachments
8 pieces REF 430 0735 0

Screw connection set, partly preassembled Overview of products



Fig. 1:1
Titanium screw
1 piece REF 330 0070 0
10 pieces REF 330 0071 0



Fig. 1:1
Closing ring HL, cast-on
2 pieces REF 430 0730 4



Tapped bush HL
2 pieces REF 330 0081 1

Tool set for individual screw connections Overview of products



Fig. 1:1
Titanium screw
M 1.4 x 0,3
Head length 2,5 mm
1 piece REF 330 0070 0
10 pieces REF 330 0071 0



Titanium screw
M 1.6 x 0.35
Head length 2.5 mm
REF 330 0116 0
REF 330 0116 1



Titanium screw extended head
M 1.4 x 0.3
Head length 3.5 mm
REF 330 0K70 0
REF 330 0K71 0

Titanium screw extended head
M 1.6 x 0.35
Head length 3.5 mm
REF 330 K116 0
REF 330 K116 1



Bridge-sectioning Attachment oc

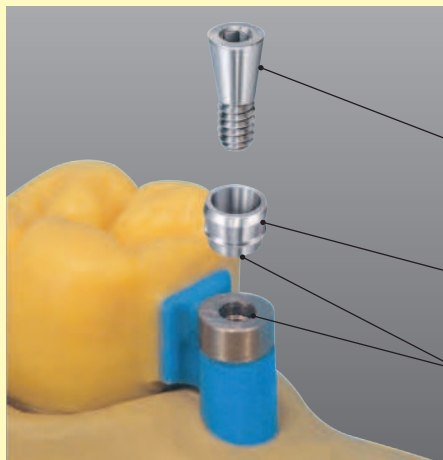

This prefabricated unit facilitates fabrication of a sectioned bridge with occlusal screw.

The titanium screw has a hexagonal socket to facilitate tightening and loosening it.

The circumferential ring marks the maximum level to which it can be shortened.

Made of cast-on alloy.

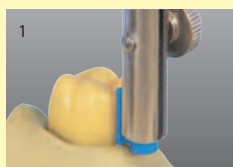

1 The paralleling mandrel positions the sectioning attachment correctly.

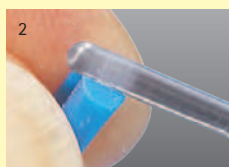

2 The design and minimal dimensions of the threaded sleeve in the sectioning attachment enable it to be adapted to the papillae as required.



3 The threaded sleeve is made of a cast-on alloy and can be used with any gold or semi-precious alloy.

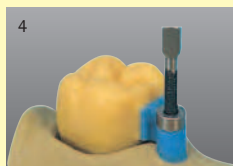

4 The fixing screw which is coated with colloidal graphite retains the threaded sleeve precisely in the investment material.



5 The section connecting the attachment to the coping is rounded, has a diameter of 1.0 mm* and can be trimmed accurately with a 1.0 mm rotary cutter if required.



6 The circumferential ledge on the locking ring marks the level to which the screw and locking ring can be reduced.



7 To ensure that the locking ring is fixed in place securely, the outer section must be moulded with Pi-Ku-Plast brush-on resin.



8 The exterior design of the locking ring, which consists of a cast-on gold alloy, ensures that it is retained securely in resin.



9 The bridge pattern is waxed up onto the resin outer section.



10 The titanium screw can be ground to blend it into the occlusal surface.

Assortment

6 pieces, 1 piece each	Fixation screw
Titanium screw	Paralleling mandrel
Closing ring HL, cast-on	Screwdriver short
Bridge sectioning studs oc	REF 430 0730 2



Custom Bridge-sectioning Attachment

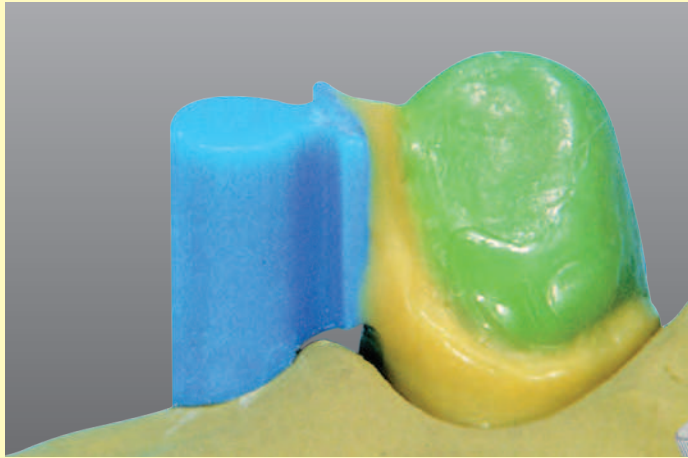

Reliable processing with the complete set of tools simplifies the fabrication of all types of bridge-sectioning attachments.

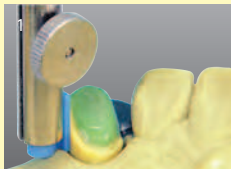

A paralleling mandrel is used to position the bridge-sectioning attachment as required for the case.



The plastic component can be adapted to the papillae as required.

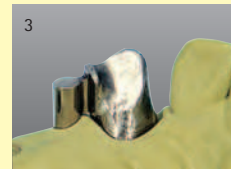

The section connecting the attachment to the coping is rounded, has a diameter of 1.0 mm* and can be trimmed with a cylindrical cutter (size 010) if required.

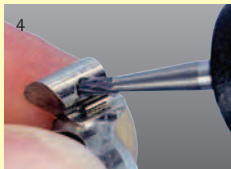

The purchase point is created with a centring drill.

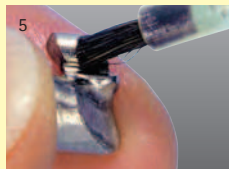

Bredent milling/drilling oil should be used when drilling. All other oils, especially etheric oils, are unsuitable and impede correct drilling.

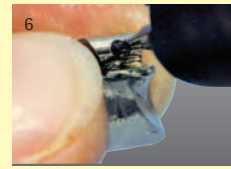

A Multidrill (1.2 x 5) from the tool set is used to drill an approximately 2 mm deep hole. The use of generous amounts of drilling oil prevents the drill overheating.

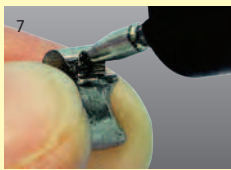

Use a stop drill (1.2 x 2) to drill the threaded hole precisely to the required depth. Use Bredent drilling oil to ensure that the hole is drilled neatly and smoothly.



A countersinking drill is used to widen the hole to 1.4 mm for the thread tap and create space for the conical screw head.

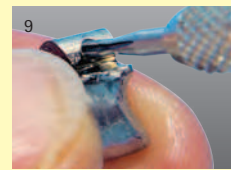

The pre-tap taps the first stage of the thread. The final tap taps a high precision thread. Drilling oil prevents the tap jamming.

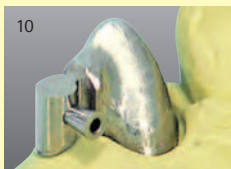

The conical screwhead fits into the inner section by approximately 3/10 mm. It withstands higher shear forces (155 kg) than conventional systems.



The screw should be coated with Pi-Ku-Plast resin and integrated into the pattern. The screw should be reduced after casting.



The minimal dimensions of the screw provide pleasant aesthetics for all screw-retained restorations.



Prefabricated screwing set

For occlusal and horizontal screw connections.

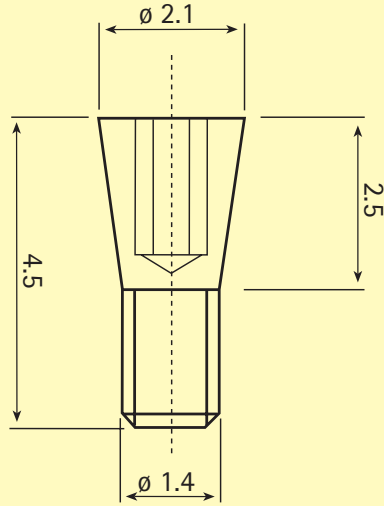

Titanium screw
M 1,4 x 0,3



Titanium screw
1 piece
REF 330 0070 0
10 pieces
REF 330 0071 0

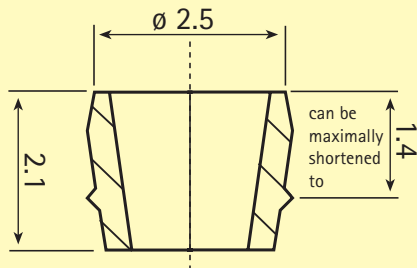

Closing ring HL,
cast-on



**Closing ring HL,
cast-on**
2 pieces
REF 430 0730 4

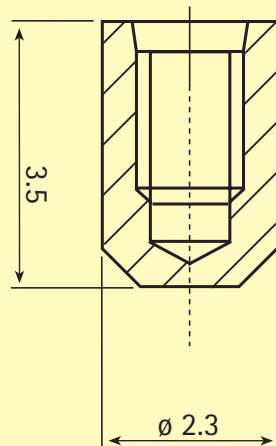

Tapped bush HL

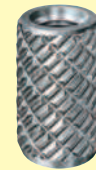

Tapped bush HL
2 pieces
REF 330 0081 1

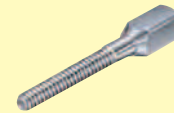

Fixation screw
2 pieces
REF 360 0103 0



Screwdriver short
1 piece
REF 330 0069 0

Assortment

5 pieces, 1 piece each
Titanium screw
Closing ring HL, cast-on
Tapped bush HL
Fixation screw M 1.4
Screwdriver short
REF 430 0735 1



Tool set for individual screw connections 1.4 and 1.6



Fast, inexpensive and tension-free screw connections.

For any situations and possibilities of dental technical screw connections.

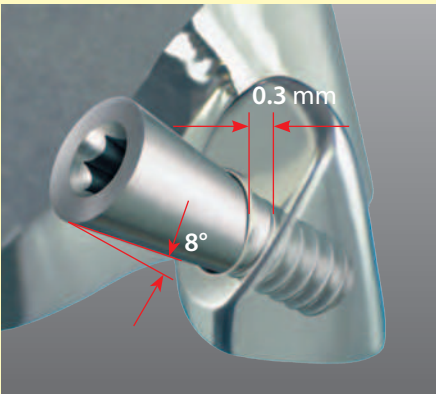

The screw head is lowered 0.3 mm deep into the primary element. This way maximum tensile strength and protection against acting shear stress are ensured.

The conical screw head provides a self-locking effect. It is not possible for the screw to loosen itself. Individual screw connections must be prepared for all gold content alloys at the points dictated by the dental-technical conditions. This way new dental-technical indications are obtained.



Perfectly suitable for two-section bridges and dentures that are removable to a limited degree.



Two possibilities for a successful screw connection

The quick screw connection without milling machine, only with the handpiece



1 Theatrix of the bridge-sectioning attachment features the same direction of insertion as residual abutment teeth.



2 Wax-up the second bridge element, cast and finish.

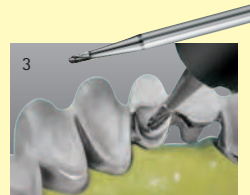

3 Prepare a small groove at the point where the screw is to be placed.

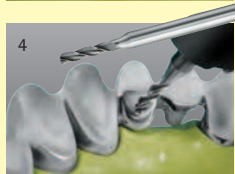

4 Drill through the secondary element approx. 1.5 mm deep into the primary element using the Diatit-Multidril.



5 Remove the secondary element and drill into the primary element up to the stop using the Diatit-Multidril with stop.

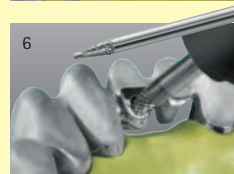

6 Assemble the primary and secondary element and drill up to the stop using the tungsten carbide facing cutter.

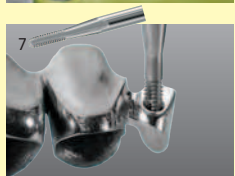

7 Cut the thread into the primary element. First use the first tap and then the last tap.



8 Assemble primary and secondary element and turn into the screw.

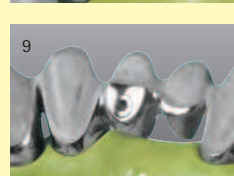

9 The screw head with the secondary element is ground flush and polished.

Use of the auxiliary modelling element

The safe method once the direction of the screw has been determined

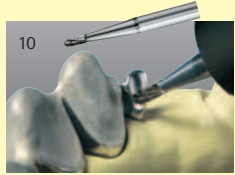

10 Grind a small groove into theatrix using the center drill.



11 The Diatit-Multidril drills down to the exact depth.

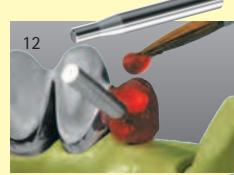

12 Integrate the auxiliary modelling element into the pattern using the brush resin.

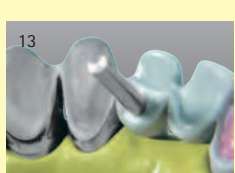

13 Complete the pattern using modelling wax.



14 Turn the auxiliary modelling element with a pair of pliers and remove it.



15 After casting, assemble the bridge elements. Drill to the stop using the facing cutter. Further working steps are described in figures 7, 8 and 9.

Available in two different thread sizes.

Assortment

10 pieces
Tool set for individual screw connections
M 1.4
REF 330 0060 0



Assortment

10 pieces
Tool set for individual screw connections
M 1.6
REF 330 0001 6





Bridge-sectioning Attachment oc

Accessories

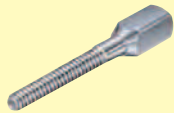

Fixation screw
2 pieces REF 360 0103 0

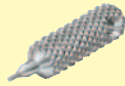

Screwdriver short
1 piece REF 330 0069 0



Paralleling mandrel
for oc and custom
bridge-sectioning
attachments
1 piece REF 360 0115 7

Custom Bridge-sectioning Attachment

Accessories



Tool set M 1,4
10 pieces REF 330 0060 0



Milling/drilling oil
REF 550 0000 8



Paralleling mandrel
for oc and custom
bridge-sectioning
attachments
1 piece REF 360 0115 7

Tool set for individual screw connections

Accessories



HM-Centring drill Ø 1,4
for M 1.4 and M 1.6
REF 330 0066 0



Diatit-Multidrill
M 1,4 REF 330 0063 0
M 1,6 REF 330 0115 7



**Diatit-Multidrill
with stop**
M 1,4 REF 330 0075 0
M 1,6 REF 330 0115 8



Facing cutter
M 1,4 REF 330 0065 0
M 1,6 REF 330 0115 9



Tap holder
REF 330 0068 0



First tap
M 1,4 REF 330 0067 1
M 1,6 REF 330 0116 V



Second taper
M 1,4 REF 330 0067 0
M 1,6 REF 330 0116 F



**Auxiliary modelling
element**
M 1,4 REF 330 0115 6
M 1,6 REF 330 0116 3



Screwdriver short
1 piece REF 330 0069 0



Milling/drilling oil
REF 550 0000 8



Tools



Screwdriver long
1 piece
REF 330 0081 2

The long screwdriver allows perfect visual control of the horizontal path of screwing in the laboratory. The screw connection can be more easily achieved by the dentist. For screws with 0.9 mm hexagon socket.

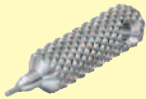

Screwdriver short
1 piece
REF 330 0069 0

Ideal for practice and laboratory. The grooved handle simplifies turning in of screws since safe hold is ensured. For screws with 0.9 mm hexagon socket.



Screwdriver for contra-angles
1 piece
REF 330 0081 3

For mechanical turning in of screws with 0.9 mm hexagon socket. The use of special motors allows to control the torque.



Screwdriver-Set

Assortment

3 pieces
1 x Screwdriver long
1 x Screwdriver short
1 x Screwdriver for contra-angles
REF 330 0081 0



Screwdriver is for contra-angles
1 piece
REF 460 0001 0



Screwdriver is manual short
1 piece
REF 460 0001 1

Special screwdrivers for the vks-oc rs abutments. Suitable as manual screwdriver and for contra-angles for enhanced control of the torque with special motors.



Screwdriver for stud-head screw
1 piece
REF 330 0116 4

Screwdriver for the stud-head screw vks-oc/sg 1.7 exchangeable stud.

Accessories



Milling/drilling oil
20 ml
REF 550 0000 8

Especially developed for the milling and drilling technique.

This milling and drilling oil does not contain any ethereal additives. Accordingly, the evaporation temperature is increased considerably; gumming of the oil is no longer possible. Due to special components and the particular consistency, the oil film remains between the metal and the milling tool. This results in the fact that metal chips come out of the cutting sections of the burs more quickly and thus easier milling is possible. The cutting performance and the service life of the milling tools is enhanced correspondingly. By using this milling and drilling oil, more material can be removed while exerting less pressure and obtaining a considerably smoother surface. The oil that has been especially developed for dental techniques withdraws the heat during processing of the object more quickly and avoids overheating of the milling and drilling tools.

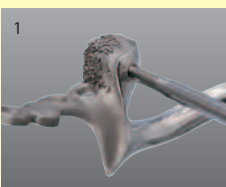

1 When tapping, always use a rich quantity of milling and drilling oil. This simplifies turning in of the tap.



2 The surface of the object becomes clearly smoother if the oil is used.



3 This milling and drilling oil avoids overheating of the milling and drilling tools; consequently, the service life of the milling tools is increased considerably.

Use:

Always use a rich quantity of milling and drilling oil during centring, drilling, milling and tapping.



Universal screwdriver set

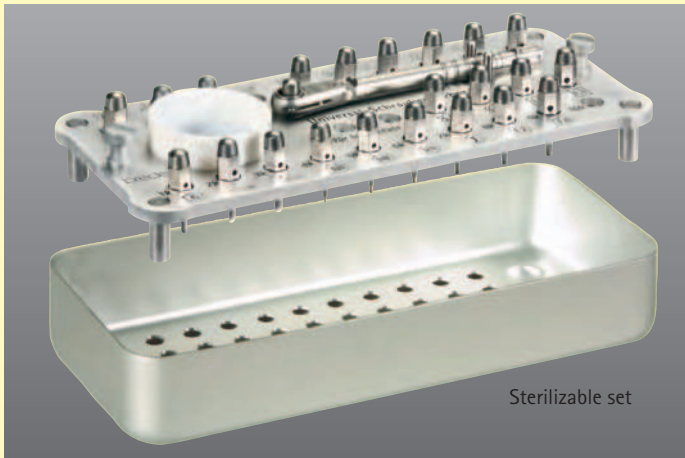

Sterilizable set

Screwdriver set for 98% of all screws available on the market. To be inserted into the torque ratchet, adjustable from 10 to 40 Ncm. This way screws can be turned in correctly and safely.

Universal screwdriver set with instruments
REF 310 0001 2

Universal screwdriver set without instruments
REF 310 0001 1

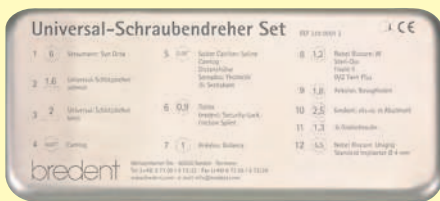

On the lid you can find important information required for the quick selection of the necessary screwdriver.



Universal screwdriver set to loosen and tighten all types of screwed implant abutments.



Screwdriver long

6	Screwdriver	1	Torx 6	REF 310 0010 1
—	Screwdriver	2	slotted 1.6	REF 310 0010 2
—	Screwdriver	3	slotted 2	REF 310 0010 3
—	Screwdriver	4	0.03" only available as short type	
0.05	Screwdriver	5	Allen 0.05"	REF 310 0010 5
0.9	Screwdriver	6	Allen 0.9	REF 310 0010 6
1	Screwdriver	7	Allen 1.0	REF 310 0010 7
1.2	Screwdriver	8	Allen 1.2	REF 310 0010 8
1.8	Screwdriver	9	Allen 1.8	REF 310 0010 9
2.5	Screwdriver	10	Hexagon 2.5	REF 310 0011 0
1.3	Screwdriver	11	Square 1.3	REF 310 0101 1
5.5	Screwdriver	12	Torx 5.5	REF 310 0101 2



Screwdriver short

6	Screwdriver	1	short	Torx 6	REF 310 00K0 1
—	Screwdriver	2	short	slotted 1.6	REF 310 00K0 2
—	Screwdriver	3	short	slotted 2	REF 310 00K0 3
0.03	Screwdriver	4	short	Allen 0.03"	REF 310 00K0 4
0.05	Screwdriver	5	short	Allen 0.05"	REF 310 00K0 5
0.9	Screwdriver	6	short	Allen 0.9	REF 310 00K0 6
1	Screwdriver	7	short	Allen 1.0	REF 310 00K0 7
1.2	Screwdriver	8	short	Allen 1.2	REF 310 00K0 8
1.8	Screwdriver	9	short	Allen 1.8	REF 310 00K0 9
—	Screwdriver	10		Allen 2.5 only available as long type	
1.3	Screwdriver	11	short	Square 1.3	REF 310 00K1 1
5.5	Screwdriver	12	short	Torx 5.5	REF 310 00K1 2



Universal screwdriver set for contra-angles

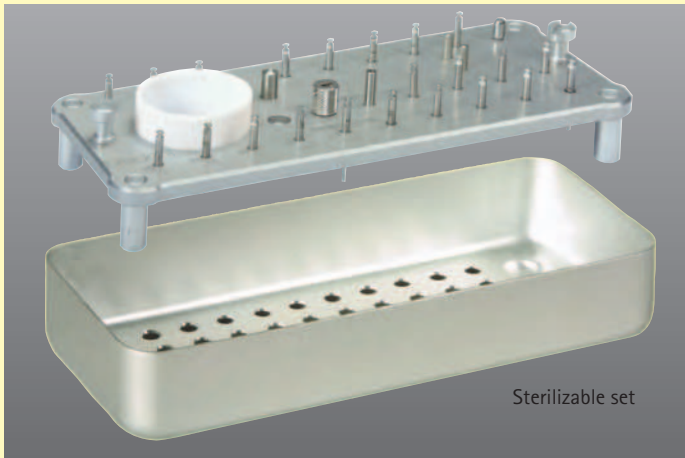

Sterilizable set

Screwdrivers with seating for contra-angles. Thanks to the integrated torque they simplify turning in screws with special motors. In conjunction with the adapter, the screwdrivers can also be used with the torque ratchet.

Universal Screwdriver-Set for contra-angles, with instruments
REF 310 W001 2

Universal Screwdriver-Set for contra-angles, without instruments
REF 310 W001 1

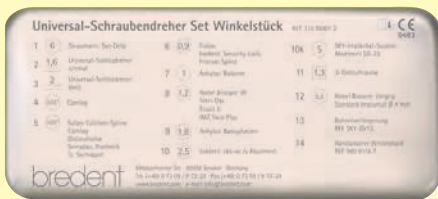

Screwdriver long	
	Screwdriver 1 Torx 6 REF 310 W010 1
	Screwdriver 2 slotted 1.6 REF 310 W010 2
	Screwdriver 3 slotted 2 REF 310 W010 3
	Screwdriver 4 0.03" only available as short type
	Screwdriver 5 Allen 0.05" REF 310 W010 5
	Screwdriver 6 Allen 0.9 REF 310 W010 6
	Screwdriver 7 Allen 1.0 REF 310 W010 7
	Screwdriver 8 Allen 1.2 REF 310 W010 8
	Screwdriver 9 Allen 1.8 REF 310 W010 9
	Screwdriver 10 Hexagon 2.5 REF 310 W011 0
	Screwdriver 11 Square 1.3 REF 310 W101 1
	Screwdriver 12 Torx 5.5 REF 310 W101 2

Screwdriver short	
	Screwdriver 1 short Torx 6 REF 310 W0K0 1
	Screwdriver 2 short slotted 1.6 REF 310 W0K0 2
	Screwdriver 3 short slotted 2 REF 310 W0K0 3
	Screwdriver 4 short Allen 0.03" REF 310 W0K0 4
	Screwdriver 5 short Allen 0.05" REF 310 W0K0 5
	Screwdriver 6 short Allen 0.9 REF 310 W0K0 6
	Screwdriver 7 short Allen 1.0 REF 310 W0K0 7
	Screwdriver 8 short Allen 1.2 REF 310 W0K0 8
	Screwdriver 9 short Allen 1.8 REF 310 W0K0 9
	Screwdriver 10 Allen 2.5 only available as long type
	Screwdriver 11 short Square 1.3 REF 310 W0K1 1
	Screwdriver 12 short Torx 5.5 REF 310 W0K1 2

Accessories



Torque ratchet
Torque adjustable from 10 to 40 Ncm
REF 330 0115 5



Ratchet adapter
REF 580 0116 8

Caelo

Caelo is the digital platform of the brent group for retention and

structural elements in the digital workflow. We offer you comprehensive support around CAD/CAM techniques. Go

to www.caelo-dental.net to learn more about our prosthetic solutions.

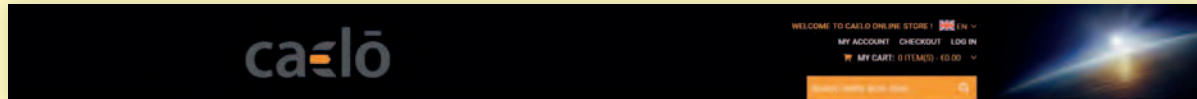

NEWS	→ New products, fairs and events
MARKETING / VIDEO	→ Product-related information / application videos
3D/CAM CUTTER	→ Webshop / Burs CNC systems
MILLING CENTER	→ External milling contractors - brent products
CAD LIBRARY	→ Download section / various design datasets - CAD
MILLING BLANKS	→ Webshop / milling blanks
OFFERS	→ Special offers and campaigns

CAD library



brent offers you a free download of our CAD software in the section of retention and structural elements. The file "Bre-

dent Library attachments_abutments.zip" can be directly downloaded and added to the CAD software below. The libraries can be used for 3Shape | exocad

| DentalWings, version 1.6 or higher.

Our CAD library includes the following structural elements:

- Vario-Soft 3 / Vario-Soft 3 mini sv
- vks 1,7 / vks 2,2
- SKY uni.fit for fabricating an individual abutment (titanium adhesive base)
- SKY fast & fixed
- SKY uni.cone
- Vario-Soft 3 sv
- Vario-Soft 3 sv zirconium
- Vario-Soft 3 mini sv zirconium
- Vario-Stud-Snap sg 1,7
- Vario-Stud-Snap sg 2,2
- Double-T Adhesive Connector 90° A
- Double-T Adhesive Connector 120° A
- SKY elegance prefab (BioHPP)
- SKY prefab titanium

To integrate the required CAD library, one-time registration for the CAELO

system is required. Following the registration, you will receive a mail confirming your registration and including an

activation link that is used to complete the registration process.

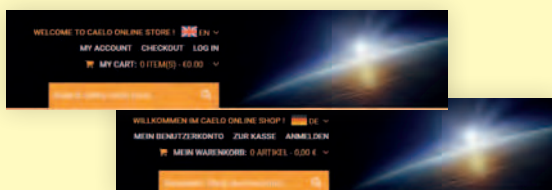

In the Manuals/Video section you can find various product and application videos about our milling blanks including application examples and processing instructions for safe and efficient processing of the products.

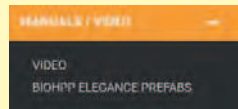

BioHPP® elegance prefab

The first gap-free, physiological hybrid abutment in the world

- Angulation up to 20°
- Maximum customizability
- Extremely convenient processing
- Can be ground, also in situ
- No adhesive gap
- Protects the antagonist teeth
- Optimized osseointegration
- Optimal gingival management
- Durability of the restoration
- Natural feeling in the mouth and on chewing
- Natural aesthetics
- Enables immediate restorations
- Enables one-time therapy

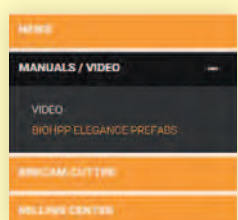
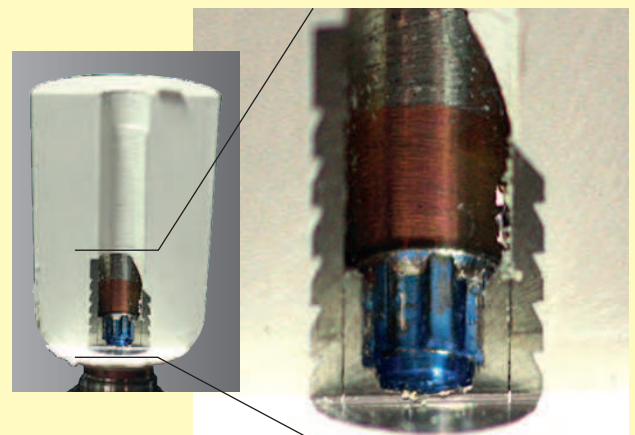
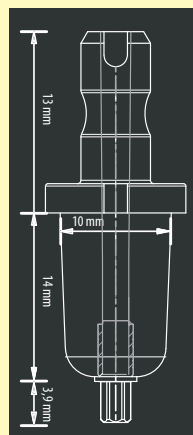

More information at www.caelo-dental.net

Can be processed with our system partners













Interlock



Product	Pieces	REF	Ø mm	Width	Height
Interlock 0°	8	430 0736 9	0.9	2.2	6.0
Interlock 2°	8	430 0736 8	1.4	1.0/1.4	6.0



Vario-Stud-Snap vks-oc

Matrix housings and matrices

Product	Pieces	REF	Ø mm	Height mm
 Metal matrix housings mmg vks-oc 1,7	2	430 0697 0	3.5	2.3
Metal matrix housings mmg vks-oc 1,7	8	430 0661 0	3.5	2.3
Metal matrix housings mmg vks-oc 2,2	2	430 0696 0	4.3	3.1
Metal matrix housings mmg vks-oc 2,2	8	430 0547 0	4.3	3.1
 Titanium matrix housings tmg vks-oc 1,7	2	430 0699 0	3.5	2.3
Titanium matrix housings tmg vks-oc 2,2	2	430 0698 0	4.3	3.1
 Titanium matrix housings for glueing vks-oc rs 2,2	2	440 0020 2	4.0	3.2
 Titanium matrix housings for fixation in acrylics vks-oc rs 2,2		440 0030 8	4.2	3.2
 Duplicating matrices vks-oc rs 2,2	8	440 0110 8	4.4	3.4
 Matrices vks-oc 1,7, green	8	430 0655 0	2.7	2.0
Matrices vks-oc 2,2, green	8	430 0544 0	3.3	2.7
Matrices vks-oc 1,7, yellow	8	430 0659 0	2.7	2.0
Matrices vks-oc 2,2, yellow	8	430 0545 0	3.3	2.7
Matrices vks-oc 1,7, red	8	430 0656 0	2.7	2.0
Matrices vks-oc 2,2, red	8	430 0546 0	3.3	2.7
 Matrices vks-oc rs 2,2, green	8	440 0070 8	3.3	3.0
Matrices vks-oc rs 2,2, yellow	8	440 0080 8	3.3	3.0
Matrices vks-oc rs 2,2 red	8	440 0090 8	3.3	3.0
 Blocking out discs vks-oc 1,7	8	430 0652 0	2.8	0.4
Blocking out discs vks-oc 2,2	12	430 0540 0	3.5	0.4
Blocking out discs vks-oc rs 2,2	8	440 0010 8	4.4	0.75

Patrices

vks-oc uni

Product	Pieces	REF	Ø mm	Height mm
 Patrices vks-oc/sg uni 1,7	8	430 0676 0	1,7 Stud	2,2
Patrices vks-oc/sg uni 2,2	8	430 0538 0	2,2 Stud	3,2
 Patrices vks-oc uni 1,7 HL-patrix cast-on	2	430 0701 0	1,7 Stud	2,2
Patrices vks-oc uni 2,2 HL-patrix cast-on	2	430 0700 0	2,2 Stud	3,2

vks-oc







Product	Pieces	REF	Ø mm	Length mm	Height mm
Patrices vks-oc 1,7	8	430 0734 5	1,7 Stud	5,8	3,9
Patrices vks-oc 1,7	8	430 0734 7	1,7 Stud	6,6	6,6
Patrices vks-oc 2,2	8	430 0539 0	1,7 Stud	6,7	7,5



Vario-Stud-Snap vks-oc



Patrices

Exchangeable stud vks-oc

Product	Pieces	REF	Ø mm	Thread mm	Height mm
 Stud-head screws vks-oc/sg 1,7 titanium	1	450 0005 6	1,7 Stud	M 1,6 x 0,2	2,9
Stud-head screws vks-oc/sg 2,2 titanium	1	450 0004 7	2,2 Stud	M 2 x 0,25	3,5
 Thread sleeves vks-oc 1,7 HL	1	450 0005 4	3,4		1,7
Thread sleeves vks-oc 1,7 platinum-iridium	1	450 0005 5	3,4		1,7
Thread sleeves vks-oc 2,2 HL	1	450 0004 6	3,4		1,7
Thread sleeve vks-oc 2,2 platinum-iridium	1	450 0005 3	3,4		1,7
 Auxiliary modelling element 1.7	1	450 0007 3			
Auxiliary modelling element 2.2	1	450 0007 5			
 Thread sleeves titanium 1.7	2	450 0007 4		M 1,6 x 0,2	1,9
Thread sleeves titanium 2.2	2	450 0007 6		M 2 x 0,25	1,9





Vario-Stud-Snap vks-sg

Matrix housings and matrices



Product	Pieces	REF	Ø mm	Width mm	Height mm	Depth mm
 Matrix housings vks-sg 1,7	8	430 0670 8		4,1	3,5	10,5
Matrix housings vks-sg 2,2	8	430 0680 8		5,1	4,5	11
 Matrices snap-in friction vks-sg 1,7, green	8	430 0668 0	1,7	3,2	3,1	2,3
Matrices snap-in friction vks-sg 1,7, yellow	8	430 0666 0	1,7	3,2	3,1	2,3
Matrices snap-in friction vks-sg 1,7, red	8	430 0664 0	1,7	3,2	3,1	2,3
 Matrices snap-in friction vks-sg 2,2, green	8	430 0541 0	2,2	4,2	4,1	2,85
Matrices snap-in friction vks-sg 2,2, yellow	8	430 0542 0	2,2	4,2	4,1	2,85
Matrices snap-in friction vks-sg 2,2, red	8	430 0543 0	2,2	4,2	4,1	2,85

Patrices

vks-sg

Product	Pieces	REF	Ø mm	Width mm	Height mm	Depth mm
 Patrizen vks-oc/sg uni 1,7	8	430 0676 0	1,7 Stud		2,2	
Patrizen vks-oc/sg uni 2,2	8	430 0538 0	2,2 Stud		3,2	
 Patrices vks-oc uni/HL 1,7 cast-on	2	430 0701 0	1,7 Stud		2,2	
Patrices vks-oc uni/HL 2,2 cast-on	2	430 0700 0	2,2 Stud		3,2	
 Patrices vks-sg 1,7	8	430 0670 0	1,7 Stud	3,0	4,1	2,2
Patrices vks-sg 2,2	8	430 0537 0	2,2 Stud	3,8	5,4	3,5
 Vario-Stud-Snap vks-sg/sg 1,7	8	430 0735 3	1,7 Stud	3,5	4,5/5,5	4,3

Exchangeable stud: vks-sg

Product	Pieces	REF	Ø mm	Thread mm	Width mm	Height mm	Depth mm
 Stud-head screws vks-oc/sg 1,7 titanium	1	450 0005 6	1,7 Stud	M 1,6 x 0,2		2,9	
Stud-head screws vks-oc/sg 2,2 titanium	1	450 0004 7	2,2 Stud	M 2 x 0,25		3,5	
 Thread sleeves vks-sg 1,7	1	450 0005 9			3,0	4,0	1,7
Thread sleeves vks-sg 1,7 platinum-iridium	1	450 0006 0			3,0	4,0	1,7
Thread sleeves vks-sg 2,2	1	450 0005 1			3,9	5,1	1,7
Thread sleeves vks-sg 2,2 platinum-iridium	1	450 0005 2			3,9	5,1	1,7

Bars: vks-sg bar patrix

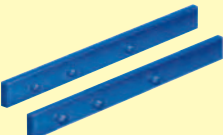
Product	Pieces	REF
 vks-sg bar patrices 1,7 incl. stud-head screw	8	430 0800 8
vks-sg bar patrices 2,2 incl. stud-head screw	8	430 0810 8



Vario-Soft 3

Matrix housings and matrices

Vario-Soft 3 matrix housings



Product	Pieces	REF	Ø mm	Width mm	Height mm	Depth mm	Max. reduction
Matrix housings	8	430 0737 6		1.8 / 4.7	5.0 / 7.6		individual
Matrices vs 3, green	8	430 0519 0		3.2	7.0	3.6	3.0
Matrices vs 3, yellow	8	430 0518 0		3.2	7.0	3.6	3.0
Matrices vs 3, red	8	430 0517 0		3.2	7.0	3.6	3.0
Duplicating matrices	8	430 0737 2					

Vario-Soft 3 sv



Product	Pieces	REF	Ø mm	Width mm	Height mm	Depth mm	Max. reduction mm
Matrices vs 3 sv, green	8	430 0565 0		3.2	7.0	3.6	3.0
Matrices vs 3 sv, yellow	8	430 0564 0		3.2	7.0	3.6	3.0
Matrices vs 3 sv, red	8	430 0563 0		3.2	7.0	3.6	3.0

Patrices

Vario-Soft 3



Product	Pieces	REF	Ø mm	Width mm	Height mm	Depth mm	Max. reduction mm
Patrices vs 3 with paralleling mandrel	8	430 0520 0	1.8	3.0	6.0/7.0	3.1	3.0
Patrices vs 3 without paralleling mandrel	8	430 0737 0					

Vario-Soft 3 sv



Product	Pieces	REF	Ø mm	Width mm	Height mm	Depth mm	Max. reduction mm
Patrices vs 3 sv	8	430 0737 4	8	3.5	6.0/7.0	5.3	3.0



Vario-Soft 3 mini / Vario-Soft 3 mini sv

Matrices

Vario-Soft 3 mini

Product	Pieces	REF	Width mm	Height mm	Depth mm	Max. reduction mm
Matrices vs 3 mini, green	8	430 0731 7	3.0	6.0	2.0	3.0
Matrices vs 3 mini, yellow	8	430 0731 5	3.0	6.0	2.0	3.0
Matrices vs 3 mini, red	8	430 0731 3	3.0	6.0	2.0	3.0

Vario-Soft 3 mini sv

Product	Pieces	REF	Width mm	Height mm	Depth mm	Max. reduction mm
Matrices vs 3 mini sv, green	8	430 0733 5	2.6	6.0	2.0	2.8
Matrices vs 3 mini sv, yellow	8	430 0733 3	2.6	6.0	2.0	2.8
Matrices vs 3 mini sv, red	8	430 0733 1	2.6	6.0	2.0	2.8

Patrices

Vario-Soft 3 mini

Product	Pieces	REF	Width mm	Height mm	Depth mm	Max. reduction mm
Patrices vs 3 mini	8	430 0732 5	3.1	6.0	2.3	3.0

Vario-Soft 3 mini sv

Product	Pieces	REF	Width mm	Height mm	Depth mm	Max. reduction mm
Patrices vs 3 mini sv	8	430 0734 3	3.5	5.8	4.1	2.8

Inverto Plus



Product	Pieces	REF	Ø mm	Depth mm	Length mm	Width mm	Height mm
Matrices HL suitable for casting-on	1	450 0004 0		1.55		2.4	5.4
Matrices resin	2	450 0004 1		1.55		2.4	5.4
Patrices 45°	1	450 00P4 5		5.1		2.5	5.0 x 3.1
Patrices 90°	1	450 00P90		5.1		2.5	5.0 x 3.1
Glue-in sleeves	1	450 0005 0	2.5			3.1	
Basal screws	1	450 0004 4	2.0		0.8		
Activating screws 45°	1	450 00A4 5	1.0		1.7		
Activating screws 90°	1	450 00A9 0	1.0		4.0		
Auxiliary duplicating elements	4	450 0004 2	2.9				3.2



Vario-Sof-Profilsteg vsp

Matrices

vsp-f – Friction



Product	Pieces	REF	Length mm	Width mm	Height mm
Friction matrices vsp-f, green	8	430 0639 0	6.5	3.0	4.5
Friction matrices vsp-f, yellow	8	430 0641 0	6.5	3.0	4.5
Friction matrices vsp-f, red	8	430 0643 0	6.5	3.0	4.5

vsp-gs – Joint snap-in



Product	Pieces	REF	Length mm	Width mm	Height mm
Joint snap-in matrices vsp-gs, green	8	430 0627 0	5.7	2.7	4.5
Joint snap-in matrices vsp-gs, yellow	8	430 0629 0	5.7	2.7	4.5
Joint snap-in matrices vsp-gs, red	8	430 0631 0	5.7	2.7	4.5

vsp-fs – Friction snap-in



Product	Pieces	REF	Length mm	Width mm	Height mm
Friction snap-in matrices vsp-fs, green	8	430 0632 0	5.6	2.7	2.3
Friction snap-in matrices vsp-fs, yellow	8	430 0635 0	5.6	2.7	2.3
Friction snap-in matrices vsp-fs, red	8	430 0637 0	5.6	2.7	2.3

VSS



Product	Pieces	REF	Length mm	Width mm	Height mm
Matrices vss green	8	430 0527 0	6.7	3.4	8.0
Matrices vss yellow	8	430 0526 0	6.7	3.4	8.0
Matrices vss red	8	430 0525 0	6.7	3.4	8.0

Bars

vsp-f

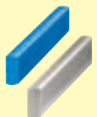

Product	Pieces	REF	Length mm	Width mm	Height mm
Resin bars vsp-f	4	430 0647 0	50	1.5	3.5
Titanium bars vsp-f	1	560 0001 0	50	1.5	3.5

vsp-gs / vsp-fs

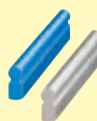

Product	Pieces	REF	Length mm	Width mm	Height mm
Resin bars vsp-fs / vsp-gs	4	430 0694 0	50	1.5	3.5
Titanium bars vsp-fs / vsp-gs	1	560 0002 0	50	1.5	3.5

VSS



Product	Pieces	REF	Length mm	Width mm	Height mm
Bars vss	8	430 0524 0	48	2.2 / 2°	7.1



Swivel-type lock sr



Product	Pieces	REF	Length mm	Width mm	Height mm	Ø mm
Latch retainer	4	430 0735 9	4.0	2.9	4.3	
Swivel-type lock	4	430 0735 7	5.8	3.8	2.9	
Latch box	4	430 0735 6	6.2	5.0	2.9	
Shear distributor housing left	4	430 0730 9	6.4	5.9	4.8	
Shear distributor housing right	4	430 0731 0	6.4	5.9	4.8	
Oxide-steel pins	20	430 0293 0	10.0			1.0

Swivel-type lock src

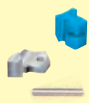

Product	Pieces	REF	Length mm	Width mm	Height mm	Ø mm
Latch retainer	4	430 0735 9	4.0	2.9	4.3	
Swivel-type lock titanium	2	430 T735 7	5.8	3.8	2.9	
Oxide-steel pins	20	430 0293 0	10.0			1.0

Locking Pin bs 1



Product	Pieces	REF	Ø mm Thread	Length mm	Max. reduction
Pin axles	2	450 0006 4	2.0	15.0	individual
Bolt screws	2	450 0006 5	M 1,6 x 0.35	4.4	

Locking Pin Snap / Locking Pin Easy-Snap



Product	Pieces	REF	Ø mm Axle	Ø mm Ring	Length mm	Ø mm
Locking Pin Snap	1	440 0065 8	1.5	3.5	3.6/6.25	2.8

Locking Pin activatable



Product	Pieces	REF	Ø mm Axle	Ø mm Ring	Length mm	Width mm	Height mm
Locking Pin activatable	2	430 0459 0	1.5	2.9			
Locking Pin activatable mini	2	430 0500 0	1.5	2.9			
Locking Pin matrices	4	430 0458 0			5.6	2.5	4.1
Locking Pin matrices mini	4	430 0490 0			4.6	1.9	3.6
Locking Pin patrices	4	430 0458 0			5.4	3.7/1.2	3.4
Locking Pin patrices mini	4	430 0490 0			4.3	3.7/0.9	2.8



Activatable friction cylinder



Product	Pieces	REF	Thread	Depth mm	Width mm	Height mm
Friction cylinders	2	440 0068 0		2.4	2.4	3.2
Titanium screw	2		M 1,4 x 0,3			2.6

Cylindrical attachment zg



Product	Pieces	REF	Ø mm	Height mm
Metal matrix housings K	2	440 0230 2	4.8	4.2
Titanium matrix housings M	2	440 0240 2	4.3	4.2
Matrices Friction	8	440 0150 8	3.75	3.8
Matrices Friction	8	440 0140 8	3.75	3.8
Matrices Friction	8	440 0130 8	3.75	3.8
Matrices Snap	8	440 0180 8	3.75	3.8
Matrices Snap	8	440 0170 8	3.75	3.8
Matrices Snap	8	440 0160 8	3.75	3.8

Stud fixator



Product	REF	Length mm	Ø mm
Stud fixator	440 0265 1	3.7	2.2





Security-Lock

Product	Pieces	REF	Ø mm	Length mm	Thread mm	Length/Rod mm	Max. reduction mm
 Threaded rods titanium 1,0	2	430 0729 3	Rod 1,0	8.5	M 2 x 0.4	3.5	2.3
 Threaded rods titanium 1,4	2	430 0729 4	Rod 1,4	8.5	M 2 x 0.4	3.5	2.3
 Threaded rods titanium 1,8	2	430 0729 5	Rod 1,8	8.5	M 2,5 x 0.45	3.5	2.3
 Matrix sleeves HL 1,0	2	430 0729 6	2.8	5.3			2.3
 Matrix sleeves HL 1,4	2	430 0729 7	2.8	5.3			2.3
 Matrix sleeves HL 1,8	2	430 0729 8	3.2	5.3			2.3





Security-Lock-Ceramic

Product	Pieces	REF	Ø mm	Length mm	Thread mm	Length/Rod mm	Max. reduction mm
 Threaded rods titanium 1,4	2	430 0729 3	Rod 1.4	8.5	M 2 x 0,4	3.5	2.3



Security-Lock-adhesive sleeve

Product	Pieces	REF	Ø mm	Length mm	Thread mm	Length/Rod mm	Max. reduction mm
 Threaded rods titanium 1,4	2	430 0729 4	Rod 1.4	8.5	M 2 x 0.4	Rod 3.5	2.3
 Matrix sleeves Titan 1,4	2	430 0739 7	2.8	5.3			2.3

Tool set for individual screw connections 1.4 and 1.6

Product	Piece	REF	Ø mm	Length mm	Thread mm	Length/Head mm	Max. reduction mm
 Titanium screws M 1,4	1	330 0070 0	2.1	4.5	M 1,4 x 0.3	2.5	1.2
 Titanium screws M 1,4 / 3,5	1	330 0K70 0	2.3	5.5	M 1,4 x 0.3	3.5	1.8
 Titanium screws M 1,6	1	330 0116 0	2.3	5.2	M 1,6 x 0.35	2.5	1.2
 Titanium screws M 1,6 / 3,5	1	330 K116 0	2.6	6.2	M 1,6 x 0.35	3.5	2.0



Bridge-sectioning Attachment oc

Product	Pieces	REF	Ø mm	Length mm	Thread mm	Length/Head mm	Max. reduction mm
 Titanium screws M 1,4	1	330 0070 0	2.1	4.5	M 1,4 x 0.3	2.5	1.4
 Closing ring HL	2	430 0730 4	2.5	2.1			1.4
 Bridge-sectioning studs oc	2	430 0730 3	3.0	6.9	M 1,4 x 0.3		3.3

Custom Bridge-sectioning Attachment

Product	Pieces	REF	Ø mm	Length mm	Thread mm	Length/Head mm	Max. reduction mm
 Custom Bridge-sectioning Attachment	8	430 0735 0	3.0	7.0			individual

Prefabricated screwing set

Product	Pieces	REF	Ø mm	Length mm	Thread mm	Length/Head mm	Max. reduction mm
 Titanium screws 1,4	1	330 0070 0	2.1	4.5	M 1,4 x 0.3	2.5	1.4
 Closing ring HL	2	430 0730 4	2.5	2.1			1.4
 Tapped bushes HL	2	330 0081 1	2.3	3.5			

Structural elements

Reliable retention – for a lifetime



Other offers that may be of interest to you

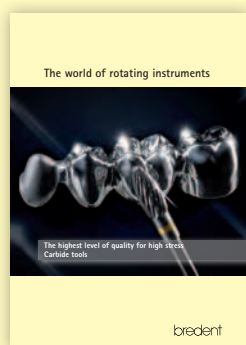

REF 000 753 GB

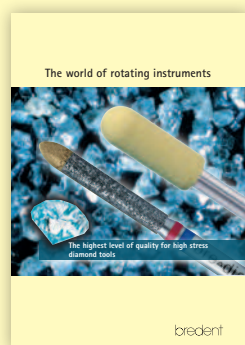

REF 000 531 GB

breident

GmbH & Co. KG · Weissenhorner Str. 2 · 89250 Senden · Germany · T: (+49) 0 73 09 / 8 72-4 41 · F: (+49) 0 73 09 / 8 72-4 44
www.breident.com · @: info@breident.com

Mistake and subject to change reserved 000570GB-20170911

